

Dear Correct Craft Owner:

Congratulations on your purchase of a Sport Nautique / Air Nautique / Pro Air Nautique. You have chosen a boat that is unequaled “on the waters of the world” for water-skiing and wakeboarding.

Since 1925, we have manufactured some of the finest products boat builders can produce.

Your boat was manufactured with the latest marine technology and materials. You have bought into a legacy handed down by W. C. Meloon over 76 years ago. His dedication to building boats to the glory of God remains true today as the cornerstone of our commitment in bringing to you the finest in water sports boats. We continue to lead this industry in technology and design innovation. Our heritage is a source of pride. Years of experience, including that of four generations of Meloons have gone into the building of your boat. We hope that you will enjoy it to the fullest.

Take a moment to review this owners manual for your boat. We have assembled this manual to inform you about your boat and educate you further on boating. There are many tips and tricks on care and maintenance sprinkled throughout the manual, along with some cautions that will apply to your boat. Boating is very important to us and we would like you to enjoy many years of boating.

Welcome into the Nautique family.

Sincerely,

A handwritten signature in black ink, appearing to read 'W. N. Meloon', with a long, sweeping horizontal line extending to the right.

Walter N. Meloon
President/Chief Executive Officer

*Trust in the Lord with all thine heart;
and lean not unto thine own understanding.
In all thy ways acknowledge him,
and he shall direct thy paths.
Proverbs 3:5-6*

TABLE OF CONTENTS

Chapter 1. Overview	Chapter . Page
Dash Pod and Console Layout	1.1
Flight Control Tower Specs.....	1.1
Keyless Ignition and Serial Switching	1.2
Multiple Keyless Ignition Codes.....	1.3
Primary User Code.....	1.3
Erasing the User Codes	1.5
Key Functions.....	1.5
Dash Pod Switches	1.6
Bilge Pump	1.6
Bilge Pump Only Mode.....	1.7
Navigation Lights	1.7
Anchor	1.7
Ventilation Blower.....	1.8
12 Volt Plug	1.8
Engine Warning Light	1.8
Gauges	1.8
Emergency Cut-off Switch	1.8
Throttle	1.9
Pylon.....	1.9
Lifting Rings	1.10
Capacity Plate	1.10
Hull Identification Number	1.11
Driver's Seat Adjustment	1.12
Love Seat	1.12
Ski Locker Latch.....	1.12
Fueling	1.12
Walk Through Windshield (optional).....	1.12
Engine Box Latching/Lifting	1.13
Dash Cooler	1.13
Stern Seat Center Cushion	1.13
Fuel Tank Location	1.13
Optional Electric Sensor in Drainplug.....	1.13
Optional Launch Control System.....	1.13
Optional Launch Control Assist Pumps.....	1.14
Winterizing Launch Control System.....	1.14
Correct Craft Cruise	1.15
Optional Flight Control Tower (folding).....	1.15
Battery Location.....	1.15
Boarding Platform Removal.....	1.15
Speedometer.....	1.16
Tachometer	1.19

Chapter 2. Engine Overview

Engine Check-List	2.1
Fuel Injected Engine Does Not Start.....	2.3
Break In Procedure	2.4
General Notes.....	2.4

Chapter 3. Cautions and Warning Labels.....3.1

Chapter 4. Boat Handling /Safety Regulations.....4.1

Chapter 5. Boat Care

Bilge Pump	5.1
Propeller	5.2
Stuffing Box	5.4
Quick Drain Oil	5.5
Salt Water Boating.....	5.6
Battery Maintenance.....	5.6
Winterizing Your Boat.....	5.7
Gelcoat Care	5.8
Teak Care.....	5.9
Glass Care.....	5.9
Metal Care	5.9
Vinyl Care.....	5.10
Tunable Rudder.....	5.11

Chapter 6. Trailering

Hitch	6.1
Security	6.1
Towing Your Boat.....	6.1
Wiring	6.1
Long Trips	6.2

Chapter 7. Warranty and Owner Responsibility.....7.1

Chapter 8. Engine Maintenance

PCM Delivery Inspection	8.1
Changing the Engine Oil	8.3
Engine Crankcase Capacity/Level	8.4
Raw Water Strainer	8.5
Transmission Cooler	8.5

Chapter 8. Engine Maintenance...

Replacing Fuel Filter	8.5
Prolonged Storage	8.6
Exhaust System	8.6
PCM Transmissions.....	8.6
Maintaining Transmission Fluid Level	8.7
Adjusting the Water Pump Belt (Ford Only)	8.7
Alternator Drive Belt Tension	8.8
Fuel Pumps	8.8
Fuel Control Cell.....	8.8
Battery	8.10
Fuel	8.10
Engine Circuit Breakers on EFI Engines	8.11
Cooling System	8.11
Fresh Water Cooling	8.12
Checking Coolant Level	8.13
Winterization Instructions.....	8.13
Winter Storage of Batteries	8.17
Recommissioning	8.17
Flushing Instruction.....	8.18
Engine Maintenance Schedule	8.19
Engine Troubleshooting.....	8.20

Chapter 9. Service Records & Order Forms

Change of Ownership.....	9.1
Problem Notification Form	9.2
Warranty Transfer	9.3
PCM Warranty	9.4
Supplemental PCM Protection Addendum	9.5
Nautique Friend Program	9.6
Correct Craft Dealer/Warehouse Locations.....	9.7
NOA Membership Form	9.8
Warranty Transfer Application	9.10
Plaque Order Form	9.11
Glossary	9.12

1

Chapter 1

OVERVIEW

Specifications Sport Nautique / Air Nautique/ Pro Air Nautique

100 % Fiberglass Construction

Length (without platform) 21' 1.75" (6.4 m)

Length (with platform) 22' 6.75" (6.88 m)

Beam (measured rubrail to rubrail) 91" (2,31 m)

Draft (not under power) 24" (0.61 m)

Water line to top of Air Nautique

Flight Control Tower 83" (2,1 m)

Water line to top of Air Nautique

Flight Control Tower (folded forward) 58" (1.47 m)

Water ballast tank Capacity (Approx. 400 lbs.) 50 Gal . (189

ltr)

Approximate Dry Weight (w/o Ballast) . . 2890 lbs. (1,310 kg)

Lifting Rings (Distance between) . . . 19' 8.5" (6.01 m)

Fuel Capacity 30 Gallons (113 ltr)

Note: Coast Guard Capacity (1190 lbs.) includes all added weight, including people, fuel, ballast, FCT, etc.



Welcome to the Sport Nautique / Air Nautique / Pro Air Nautique family.

We realize you may be anxious to get your boat in the water. This manual has been written to familiarize and educate you about your boat so you will be more comfortable out on the water. Your boat is built to provide you with the finest watersports boat in the world. Whether you are slalom skiing or ripping on a wakeboard, we trust you and your family will enjoy this boat for many years.

Let's start by taking a look at the dash pod to familiarize yourself with the locations of the gauges and switches.

Dash Pod and Console Layout

Standard equipment on your boat are the following gauges: oil pressure, engine coolant temperature, speedometer, tachometer/ hour meter, fuel level, voltage. Optional equipment gauges available include: air/water temp gauge, clock, depthfinder, Launch Control System tank gauges, remote stereo control and Correct Craft Cruise or Perfect Pass Pro speed control. The optional gauges are positioned on the console



Dash Layout

located to the right of the drivers knee.

CAUTION: The keypad and switch control box will be damaged beyond repair if the boat battery cables or the main power leads to the keypad and switch control box are reversed. Be sure to use caution and avoid reversing these connections.

Keyless Ignition and Serial Switching

The ignition switch system is keyless and has three modes of operation.

Locked Mode

When the boat battery is first connected, the unit is in locked mode. In this mode, the horn, bilge pump, bilge blower, and code buttons are operational.

Unlocked Mode

Unlocked mode is entered after the user successfully enters the user code, presses, and releases the start button. When the code keys are pressed, the system indicator light to the right of the start button will turn on while the key is pressed down. This indicates the button has actually been pushed. When the system is unlocked, power is supplied to the boat and the system indicator light will turn on. At this point all keypad buttons are operational and actuating these buttons will control the corresponding boat functions. To put the unit back in locked mode, the user must successfully enter the user code then press the stop button. When the code keys are pressed, the system indicator light to the right of the start button will turn off while the keys are pressed down. Power will be cut to all of the accessories with the exception of the horn, bilge pump, bilge blower and code buttons.

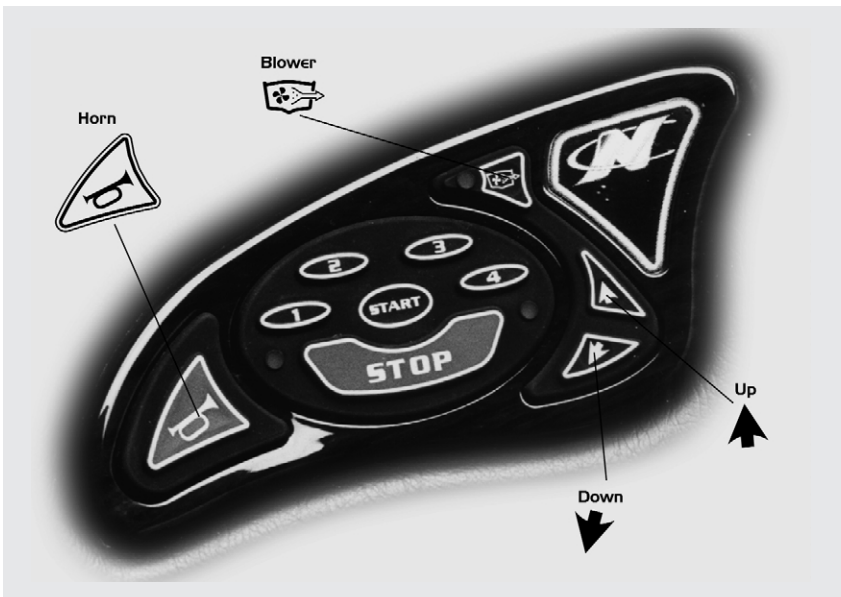

Run Mode

First enter the unlocked mode.

Pressing and releasing the start button quickly will put the unit in run mode. When this is done, power is supplied to the engine ignition, but the engine will not crank and the ignition indicator light just left of the start button is turned on. If the start button is not pressed again within 15 minutes the unit will exit run mode by shutting off power to the ignition and re-enter unlocked mode. If the user presses and holds the start button, power is supplied to the ignition and starter for as long as the user holds the start button down. All accessory buttons are operational in this mode as well. Pressing the stop button will shut off the engine and the unit is then put back in unlocked mode.

After the engine starts, release the start button.

Automatic Reversion to Locked Mode

If no keypad activity takes place for ten hours after unlocking, the system will automatically revert to the locked mode. This helps to minimize battery drain.

Automatic Back-lighting

Pressing any keypad button will automatically turn the keypad back-lighting on for ten seconds. This feature is useful for those that use their boat after dark to find the appropriate keypad buttons.

Multiple Keyless Ignition Codes

The keyless ignition system has provision for three different ignition codes. Any of the three codes may be used to unlock or lock the system.

The “Master Embedded Code” is programmed into the system at Correct Craft Inc. and is not changeable, remaining with the boat for its life. This code can be used to unlock the system, to lock the system and to erase the two user codes.

The “Primary User Code” is programmed into the system by the owner with the dealers help at the time of boat delivery. This code is used to unlock the system, to lock the system, and to add or change the “Secondary User Code”

The “Secondary User Code” is programmed into the system by the owner when necessary. This code is only used to unlock or lock the system. The “Secondary User Code” is excellent to use for limited access to the boat.

Programming and/or Changing Primary or Secondary User Code

Note: To help prevent battery drain, when you are finished using the boat make sure you STOP the engine and LOCK the PME ignition system.(two steps) Note: The “System Indicator Light” is on the ignition keypad below the number four (4). The “Ignition Indicator Light” is also on the keypad below the number one (1)

Programming the Primary User Code

Make sure that the system indicator light is off and the "Master Embedded Code" has been entered. Until a primary user code is set, the keyless ignition will behave as follows. Pressing start once will unlock the system while pressing it a second time will start the engine. Pressing stop once will turn off the engine while pressing it a second time will lock the system.

To program the primary user code, press buttons one and four at the same time, putting the system in code programming mode. The system indicator light will be flashing.

Enter a code from two to eight characters long and press start. For verification, re-enter the code and press start again. The system indicator light should stop flashing and stay on. If the light does not stop flashing, press stop and begin again.

To lock the system re-enter either the primary user code or the master embedded code and press stop.

Changing the Primary User Code

NOTE: The current primary code must be used to change to another primary code.

Make sure that the system indicator light is off. Enter the primary user code then press buttons one and four at the same time. This puts the system in code programming mode. The system indicator light will be flashing.

Enter a code from two to eight characters long and press start. For verification, re-enter the code and press start again. The system indicator light should stop flashing and stay on. If the light does not stop flashing, press stop and begin again.

To lock the system re-enter either the new primary user code or the master embedded code and press stop. Please note, changing the primary code will erase the secondary user code. The secondary code will need to be re-entered.

Programming or Changing the Secondary User Code

NOTE: The secondary code will only lock or unlock the system & can not be used for any reprogramming

Make sure that the system indicator light is off. Enter the primary user code and press buttons one and three at the same time putting the system in code programming mode. The system indicator light will be flashing.

Enter a code from two to eight characters long and press start. Re-enter the code and press start again. The system indicator light should stop flashing and stay on. If the light does not stop flashing, press stop and begin again.

To lock the system re-enter any of the three codes and press stop.

Erasing the User Codes

Make sure the system indicator light is off. Enter the master embedded code and press buttons one and three at the same time. This will erase the system user codes.

The keyless ignition will now behave as if there are no codes in memory. Pressing the start button will unlock the system and pressing the stop button will lock it without entering a code. To program a primary user code, make sure the system indicator light is off and press buttons one and four at the same time. This puts the system in code programming mode. The system indicator light will be flashing. Follow the last two steps above to complete programming the primary user code.

Key Functions

All keys with the exception of the bilge blower, bilge pump, horn, and the code keys operate in unlocked or run mode. The horn, up, down, and start buttons, (when starting the engine), are momentary buttons. All others require a press to turn on and another press to turn off.

Exceptions

Pressing the heater button will actuate the heater in the following sequence: Heater off (low(medium(high(back to off)

Pressing the LCS fill or drain will toggle the power to the corresponding function. Turning either the fill or the drain on will automatically turn the other off.

The navigation light button always controls the anchor light and if the navigation lights are on, the anchor light button will have no affect. If the navigation lights are off, the anchor light button will turn only the anchor light on and off. One special feature works when the anchor lights are on. If the user desires to turn the navigation lights on, it is unnecessary to turn the anchor lights off. Simply pressing the navigation light button will leave the anchor light on and turn on the bow light.

Dash Pod Switches

There are function key switches to the right of the helm and surrounding the keyless ignition keypad. These are waterproof momentary switches. By pressing a function key, you activate the function indicated.

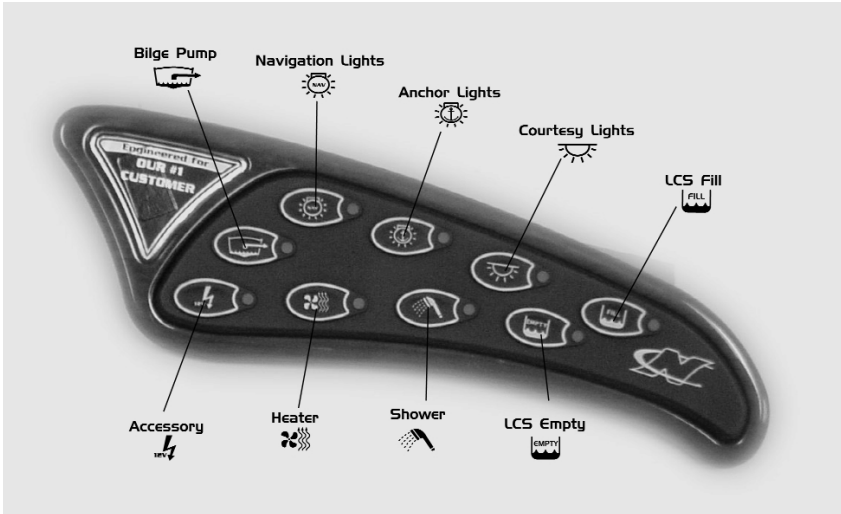

All of these switches interface with a sealed circuit breaker box located under the bow. The circuit breaker box consists of sixteen soft opaque flexible vinyl tubular shields which cover sixteen circuit switches. When the circuits are functioning, the tubular shield is somewhat flexible. A tripped circuit breaker will extend and fill the tubular shield, causing it to be inflexible. To locate a tripped circuit breaker, run your fingers over the two rows of switches and locate the switch shield that has become inflexible. To re-set, simply press in the extended circuit switch shield.

Bilge pumps

The bilge pump switch turns on the bilge pumps. There is a bilge pump down by the pylon and another bilge pump back by the rudder. When you push the bilge pump key on the keypad, both pumps will come on and run for several moments to “sense” if there is water in the bilge. If there is water in the bilge, they will remain on until the water is pumped out. If there is no water in the bilge, they will turn off. If you want immediate pump action, turn the switch off and then back on again. The pumps will turn on periodically to determine if there is water in the bilge. If so, they will remain on until the water is

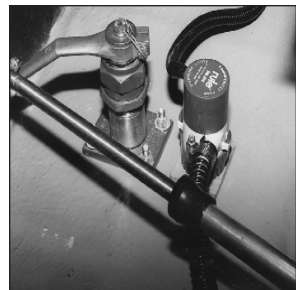

Bilge Pump

pumped out.

Note: The “Bilge” switch must be turned on for this feature to operate. This will not drain significant power from the battery unless the bilge pumps are required to run frequently because of a leak or excessive rainwater. This pumping system should not be relied on over an extended period of time. We suggest you frequently inspect your boat.

Bilge Pump Only Mode

This feature is activated by a switch located near the drivers feet on the kickboard. The switch has three positions, on, off and bilge. If the boat is going to sit for more than a few days with the bilge pump on, it is important that the switch is set in the “bilge” position to minimize battery drain.

This will activate the bilge pump and shut off power to the Serial Switching and Keyless Ignition System. It is important to remember that the engine or other accessories can not be used unless the switch is in the “on” position.

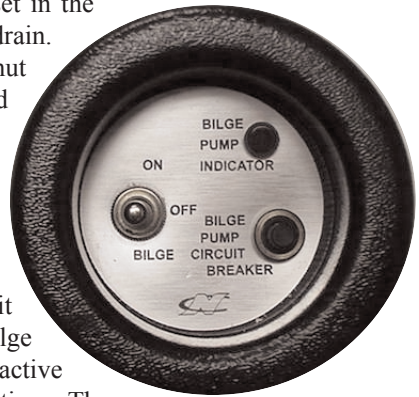

Located with the switch is a circuit breaker and indicator light for the bilge pump. The circuit breaker is only active when the switch is in the “bilge” position. The indicator light will come on anytime the bilge pump is activated.

Navigation Lights

This switch controls the navigation lights. The law requires the bow light and the 360 degree light (located at the transom) be turned on while running the boat after sunset or before dawn.

Anchor

This switch turns on the 360 degree light. Insert this light pole into the receptacle located on the transom and push the anchor switch on the pod to turn this light on. This light is required by law to be on after sunset and before dawn when the boat is not moving.

Accessories

There is an accessory button provided that controls power to a yellow wire coiled up near the control box. Power to this wire is protected by a 10-amp circuit breaker. Attaching an accessory to this wire should be done by someone knowledgeable in DC electrical wiring.

Ventilation Blower

This switch turns on the blower in the bilge. This blower must be turned on for four (4) minutes prior to engine ignition and also at anytime when the boat is operated at slow speeds.

12 Volt Plug

This plug can be utilized to power cellular phones, video cameras or various other electronics. This plug is powered through a ten (10) amp breaker.

Engine Warning Light

This light is in the center of the dash pod between the speedometer and the tachometer and indicates high engine temperature.

Horn This is a momentary switch.

Gauges on the Pod

- **Volt** This gauge tells you how many volts the alternator is producing. During normal running, it should read 13-14 volts. Running a heater, shower or stereo amplifier will draw power from the alternator and possibly drop voltage below normal. If this occurs, the battery will not charge correctly.
- **Temp** This tells you the temperature of the coolant in the engine.
- **Oil Pressure** This gauge tells you the engine oil pressure.
- **Tachometer / Hour Meter** This gauge indicates the revolutions per minute the engine is turning, and the total accumulated engine hours. The tachometer / hour meter has a digital and analog readout. Mode selection is made by pressing the mode keypad.
- **Speedometer** Your Nautique is equipped with an electronic speedometer by Teleflex. This instrument is different in many ways. It is capable of being programmed for multiple functions. This speedometer can be calibrated. To access the various functions, press and scroll through the Mode Key. To change the mode, press the INCREASE or DECREASE key. For a detailed analysis of your speedometer, refer to the Teleflex speedometer section at the end of this chapter.
- **Emergency Cut-off Switch** There is an emergency cut-off switch for the protection of you and your passengers. The clip at the end of the cord must be attached securely to the driver. Check the system by attaching the clip to the switch, start the boat and then pull the clip off the switch. The engine should stop. **UNDER NO CIRCUMSTANCES SHOULD YOU OPERATE THE BOAT IF THIS SYSTEM DOES NOT FUNCTION PROPERLY.** If it does not function correctly, contact your Correct Craft dealer to have the problem corrected.
- **Throttle** The throttle control consists of the throttle lever, a lock out ring and

a neutral button. The neutral button is a push-button at the bottom of the throttle lever which allows the throttle to be advanced without the transmission being engaged. The throttle lever must be in the neutral position to start the engine.

The throttle arm has three detent positions.

Note: When in a detent position the throttle arm will resist movement, but can be moved with sufficient pressure. Neutral detent is straight up. Forward detent is approximately 30 degrees toward the bow, and reverse detent is approximately 30 degrees toward the stern. Moving the throttle from neutral detent to either forward or reverse detent will shift the boat into that gear. The engine will remain at idle speed. To increase (forward or reverse) engine speed and therefore boat speed, continue to rotate the throttle arm past the detent.



Throttle

Note: When shifting out of neutral, it is best to pause in the appropriate detent before applying additional throttle.

The lockout ring mechanism prevents unintentional shifting into forward or reverse. To operate the throttle lever, you must lift the lockout ring. **DO NOT shift quickly from forward into reverse. Stay in the neutral position until the boat has lost speed before shifting into reverse. Shifting should not be attempted above 1200 RPM except in emergency situations.**

CAUTION: LOADING AND UNLOADING OF PASSENGERS FROM A DOCK OR FROM THE WATER SHOULD ONLY BE DONE AFTER THE ENGINE HAS BEEN TURNED OFF.

Pylon

The ski pylon is manufactured from high strength aluminum alloy that is engineered for durability. It is hard coat anodized and impregnated with a PTFE (teflon) material. If the pylon becomes loose, stop using the pylon and take the boat to your Correct Craft dealer for service.

PYLON--WARNING/CAUTION--AVOID PERSONAL INJURY. THIS WATER SKI PYLON WAS DESIGNED FOR WATER SKIING ONLY. ANY OTHER USES, SUCH AS PARASAILING, KITE FLYING, TOWING OTHER BOATS AND/OR USING AN EXTENDED PYLON, ECT., MAY OVERSTRESS THE PYLON POSSIBLY CAUSING PERSONAL INJURY AND/OR EQUIPMENT DAMAGE. DO NOT SIT BEHIND (AFT) THE TOW PYLON WHEN TOWING SKIERS.

CAUTION: ALTHOUGH THE EXTENDED PYLON AND BAREFOOT BOOMS HAVE BECOME POPULAR ADDITIONS TO MANY TOURNAMENT INBOARDS, CORRECT CRAFT STRONGLY OBJECTS AND OPPOSES THE USE OF ANY PYLON EXTENSION WHETHER UP OR TO THE SIDE OF

ANY OF IT'S PRODUCTS. THE USE OF PYLON EXTENSIONS CAN ALTER THE HANDLING CHARACTERISTICS OF THE BOAT, POSSIBLY RESULTING IN DANGEROUS INSTABILITY, WHICH COULD THEN LEAD TO LOSS OF CONTROL; A SITUATION WHICH COULD CAUSE SERIOUS OR FATAL INJURY TO THE BOAT DRIVER, PASSENGER(S), PERSON(S) BEING TOWED, AND ANYONE ELSE WHO MIGHT BE IN THE VICINITY OF SUCH A MISHAP.

CAUTION: CORRECT CRAFT DOES NOT APPROVE OF ANY STRUCTURAL CHANGES, ADDITIONS OR MODIFICATIONS TO OUR PRODUCTS. ANY TIME A DEALER OR CONSUMER MAKES A CHANGE(S) TO OUR PRODUCT, THEY DO SO AT THEIR OWN RISK AND SOLE LIABILITY. CORRECT CRAFT, INC. WILL NOT BE HELD LIABLE FOR UNAUTHORIZED CHANGES, WHETHER DELETIONS OR ADDITIONS, TO THE ORIGINAL EQUIPMENT / PRODUCT MANUFACTURED AND SOLD BY CORRECT CRAFT, INC., EVEN IF SUCH CHANGES, ADDITIONS, ECT. ARE MADE BY AN AUTHORIZED” , DEALER, CUSTOMER, PROMOTIONAL REPRESENTATIVE OR ANY OTHER PERSON, KNOWN OR UNKNOWN TO CORRECT CRAFT, INC.

Lifting rings

Your boat has lifting rings at the bow and at the stern. These are designed to lift your boat in a steady and secure manner. Be certain to use a winch that has a lifting capacity sufficient for your boat. See boat weight specs in the front of this manual. These weights are dry weight. You must add the weight of the battery, fuel, and gear to the dry weight.

CAUTION: DRAIN THE BILGE AND/OR LAUNCH CONTROL SYSTEM AND/OR AFTERMARKET WATER BLADDERS(S) TO ELIMINATE EXCESS WATER BEFORE YOU LIFT THE BOAT.



Lifting Rings

Note: Only use a hook that will pass easily through the lifting ring without binding. This is very important. A hook that is too large or off-center could break the lifting ring.

Capacity Plate

The capacity plate is used by boat manufacturers participating in the National Marine Manufacturers Association certification program. Correct Craft has submitted your model for inspection and compliance with their guidelines.

The capacity plate has the following information permanently printed on it. It is attached to the boat by the throttle for the operator to read before they drive the boat.

- The total weight of persons, gear and other items which the boat is capable of carrying under normal conditions. This weight must include any water added to the Launch Control System or other added ballast.
- The maximum number of persons allowed on the boat.

This information on the capacity plate applies under normal conditions and special care must be used in any other than normal conditions.

Check the capacity plate on your boat and abide by these limits.

NOTE: THE USE OF ANY BALLAST SYSTEM REQUIRES THE REDUCTION OF THE MAXIMUM LOAD CAPACITY LISTED ON YOUR NAUTIQUE'S CAPACITY PLATE. (I.E. IF THE MAXIMUM CAPACITY IS LISTED AS 1250 LBS AND YOU ADD 400 LBS OF BALLAST, THEN THE TOTAL WEIGHT OF PERSONS AND GEAR THAT YOU CAN CARRY IS REDUCED TO 850 LBS.

CAUTION: A FULLY LOADED NAUTIQUE WILL HANDLE DIFFERENTLY THAN A LIGHTLY LOADED ONE. DRIVE AND TURN YOUR NAUTIQUE WITH THIS IN MIND. AS WAKEBOARDING HAS DEVELOPED, WE HAVE WITNESSED THE ADVENT OF BALLAST SYSTEMS WHICH ADD WEIGHT AND INCREASE THE SIZE OF THE WAKE. THE SIMPLEST BALLAST SYSTEM ON THE MARKET IS THE WATER BALLAST TYPE, SUCH AS THE 'LAUNCH PAD". IT IS NOT UNCOMMON TO SEE OPERATORS USE SUCH SYSTEMS AND THEN PUT ADDITIONAL PEOPLE IN THEIR BOAT. PLEASE BE ADVISED THAT THIS PRACTICE CAN LEAD TO OVERLOADING OF YOUR BOAT. EACH CORRECT CRAFT, INC. BOAT HAS A REQUIRED CAPACITY LABEL THAT MEETS THE MAXIMUM WEIGHT OF PEOPLE, GEAR, AND BALLAST THAT CAN BE PLACED IN THE BOAT. ALWAYS BE AWARE OF THE LOAD IN YOUR BOAT AND DO NOT LOAD THE BOAT IN EXCESS OF THE LISTED CAPACITY. THE QUEST FOR THE "PHATTEST" WAKE HAS CAUSED SOME TO EXCESSIVELY OVERLOAD THEIR BOATS. THIS MAY ADVERSELY AFFECT



Capacity Plate

THE OPERATION OF THE BOAT, POSSIBLY RESULTING IN INJURY TO PERSONS INSIDE AND/OR OUTSIDE OF THE BOAT. AVOID PERSONAL INJURY. DO NOT OVERLOAD YOUR NAUTIQUE.

Hull Identification Number

The hull identification number is a requirement of the U.S. Coast Guard for boat manufacturers. It is a standardized numbering system that assigns a specific sequence of numbers and letters to a specific boat. This number is molded into the hull. You will find it on the right-hand side of the transom just below the rubrail. Write this number down in your records and keep it in a safe place away from the boat.

Here is a brief explanation to help you understand the hull number:

The first three digits represent Correct Craft, Inc.(CTC). The next five digits are the boat’s serial number. The following digit is a letter from “A” through “L” designating the month the boat was made.

There are three remaining numbers. The first of these represent the last digit of the year the boat was built. The final two numbers state the MODEL year. A boat built in August of 2000 is actually a 2001 model boat.

Driver’s Seat Adjustment

There is a lever under the driver’s seat on the left side that allows the seat to slide.

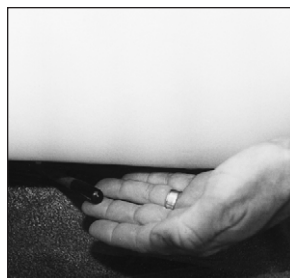

Drivers Seat Adjustment

Fueling

Remove the slotted fuel fill cap to put gas in the boat. There is a special “key” for this cap. Use caution when fueling your boat. Never fuel your boat unattended. Use care to avoid being splashed by fuel, or spilling fuel.

Ski Locker Latch

Push down on the raised portion of the latch and the handle of the latch will pop up. Lift the ski locker door with this handle. Due to various environmental conditions, equipment and other items should not be left in storage compartments for a long time. All storage compartments that get wet or damp should be left open to the air to dry.



Ski locker Latch & Locking

Love Seat

Access storage under the bow area by lifting up on the bottom of the love seat

cushion. The entire love seat will hinge upward to allow access. You can leave this seat in the “up” position to help dry the carpet

Love Seat Extension

This optional seat can be placed between the love seat and the drivers seat or behind the drivers seat.

Walk Through Windshield Opening/Latching

There are two latches on the inside starboard edge of the walk-through windshield. Rotate both of these latches until the door can be opened. Always have this closed and latched when towing the boat.

Dash Cooler

The dash cooler can be used to store misc. items or drinks. There is a drain installed in this box. Do not depend on this cooler to keep valuables or electronics dry. We suggest keeping these sort of items in a specialized dry bag.

Engine Box Latching/Lifting

There are two rubber latches that hold the top of the engine box to the base. Pull on the top of these latches and the upper part of the engine box will be released. Lift up on the engine box handle and the gas shocks will help you lift the engine box. This “clam-shell” design allows you to check the engine without lifting the entire engine box. You can leave the top open to dry the bilge.



Engine Box Latching

Optional Electric Sensor in Drainplug

The optional Electronic Sensor in Drainplug “senses” when the drainplug is installed. When the drainplug is not installed in the drain, an alarm will sound at the dash. The ignition system must be “unlocked” and the ignition indicator lit for this to function. It is the responsibility of the boat operator to make certain the drain plug is tightened sufficiently.

Stern Seat Center Cushion

The stern seat center cushion can be removed to assist getting in and out of the boat.

Stern Seat Base Removal

The stern seat provides ample seating for three or can be removed in order to provide additional space for equipment.

Trunk

There is 14 cubic feet of storage available inside the trunk (less with the ballast tank system). This is an excellent place to store skis, wakeboards and other gear.

Fuel Tank Location

The fuel tank is located beneath the stern seat. To inspect the hose connections, lift the trunk lid and remove the curtain behind the fuel tank.

Optional Launch Control System

Your boat may be equipped with a water ballast system that enhances the wake shape for wakeboarding and allows you to level the boat side to side.

There is a seacock on the bottom of the boat that controls the water supply to the ballast system. This valve should be in the closed position unless you are filling or draining the ballast system. The ability to fill the Launch Control System is controlled by valves that open and close vent fittings on the top of each ballast tank. To fill the ballast system, launch the boat and open the seacock. **Be certain the engine is**

OFF when you open the engine box to open the seacock. Turn both control knobs counter-clockwise to open the vents on both tanks. Fine tune the level of water in the tanks to level the running attitude of the boat. These knobs are located on the side console, below the radio.



Use of Launch Control System Assist Pumps

The Launch Control System assist pumps will fill and drain the Launch Control System with the boat at rest. They don't interfere with manual filling or draining as already described. In order to fill using the assist pumps, make sure that the seacock and one or both of the vent control valves are open. Push the assist pump switch.

When the tanks are full the gauges will read "full" and water will come out of the vent thru hull to the driver's right. At that point, the pumps can be switched off and the vents closed along with the seacock if so desired.

In order to drain the tanks with the assist pumps, the boat must be at rest or moving slowly in the water. Make sure that the seacock and one or both of the vent valves are open. Push the "empty" switch to pump out the water.

Please note that when the tanks are filling or draining a gurgling sound can be heard at the vent thru hull.

Winterization of Optional Launch Control System

In order to winterize the Launch Control System only three steps need to be taken:

1. Make sure that the system is completely drained.
2. Loosen the hose clamp on the hose attached to the seacock. Remove the hose from the barb and allow it to drain into the bilge of the boat until no more water is evident. Put the hose back on the hose barb and tighten the hose clamp.
3. Put the hose back on the hose barb and tighten the hose clamp.

Folding Instructions for Optional Flight Control Tower

In order to fold the Flight Control Tower forward, grasp the knobs found under the support structure on the port and starboard sides of the tower. Unscrew the threaded bolts. Rock the tower forward. The tower will rest on the grab rails of the bow section of the boat. In the folded position, it is also recommended that the tower be securely strapped to the grab rails. In order to reposition the tower in the upright position, simply reverse the steps.

Boarding Platform Removal

Pull the two pins that are located in the mounting brackets and lift the platform vertically. Make sure to keep the pins attached to the brackets on the platform so you don't lose them. If you misplace these pins, contact your dealer for a replacement set.

Battery Location

The battery is located under the front cushion in the open bow.

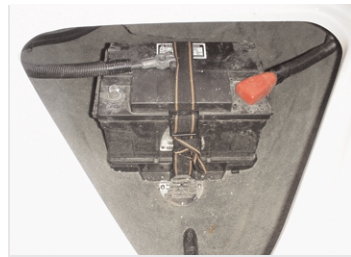

Optional Correct Craft Cruise

Turn system **ON** (light blinks slowly, indicating system is armed)

Drive to desired speed, prese ENGAGE and the system takes control of the throttle (Light stays on steady)

Pull back on the throttle and the system disengages. (Light blinks rapidly, indicating RESUME function is ready)

Accelerate again and the system resumes control automatically at the last speed used.

RESUME key feature will recall the last speed used even if the system was shut off, completely powered down or the DISENGAGE function was used. To go back to the previous speed, press RESUME and drive to the desired speed.

Press both keys and the system will DISENGAGE, but remains armed. (Light blinks slowly) This feature may be used when the operator wishes to go to manual driving. To return to the last speed used, press the RESUME key and drive to the desired speed. If the speed is to be changed, drive to that speed and press engage.

INCREASE / DECREASE key can be pressed when the system is engaged to change speed in 25 RPM increments to fine tune the speed.

User tips:

Always return to neutral and let the engine idle for two or three seconds before turning the engine off. Regularly check the black servo knob on the control unit to make sure it is turned snugly in a clockwise direction. To do this, turn the engine off and lift the top half of the engine box. Please note, the servo knob cannot be moved if the engine is on.

Regularly check the set screw on the side of the black knob for tightness.

The boat speed will decrease in sharp turns. If you are towing skiers, you may wish to manually increase the throttle or use the DISENGAGE feature to maintain speed in sharp turns.

When towing wakeboarders, accelerate slightly past desired speed prior to engaging the speed control.

TELEFLEX LCD SPEEDOMETER AND TACHOMETER SYSTEM

The LCD Speedometer and Tachometer system consists of a speedometer gauge, a tachometer gauge and a speed transducer assembly.

The speedometer gauge utilizes a LCD display to provide information to the operator and three push button switches to select the display mode. This microprocessor-based gauge communicates with the speed transducer assembly over a serial communication link. The speedometer receives input via the speed transducer assembly from the two pitot tube pressure sources and displays the highest of the two sources as the current speed.

The tachometer gauge also utilizes a LCD display and push button switch arrangement to communicate with the operator. The engine speed input to the gauge comes directly from the engine ignition system.

The speed transducer assembly connects the two pitot tubes via flexible tubing and to the speedometer gauge via a four conductor cable. The transducer converts the pressure at the pitot tubes into digital information that is sent to the gauge for processing.

Speedometer Operation

The speedometer operates in one of three “modes”. These are “Normal mode”, “Competition mode”, and “Calibration mode”. The operator switches between modes using the control buttons.

The speedometer powers on in “Normal mode” with the analog speed display, the digital speed display, and the pitot symbol active. The text line contains “NAUTIQUES” and the expanded speed display is blank. The analog and digital speed displays will indicate current speed and the pitot symbol will indicate which pitot tube is being used. Pressing the mode button once will cause the gauge to enter “Competition mode”. The analog speed display, the digital speed display, and the pitot symbol will be active as in the “Normal mode”. The text line will display the current speed deviation settings on the far ends. The minus deviation setting will be displayed on the left side and the positive setting on the right side. The current set point speed is displayed in the center. Also, the expanded speed display will be active.

The analog and digital speed displays will indicate current speed and the pitot

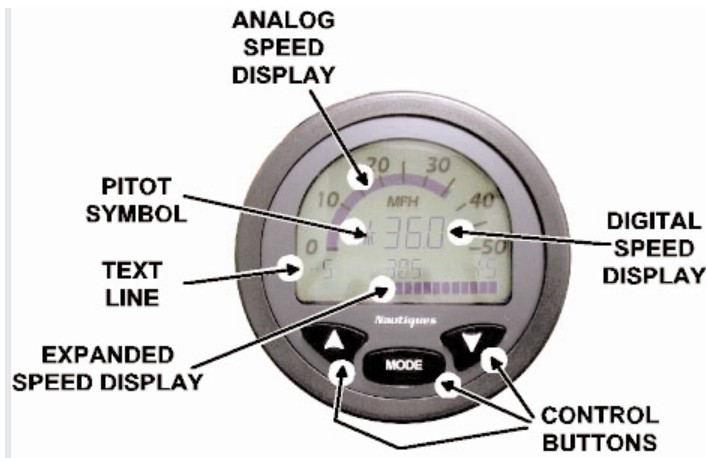

symbol will indicate which pitot tube is being used. The expanded speed display will indicate how close the current speed is to the set point speed within the displayed plus and minus limits. If the current speed is below the set point speed, bars in the expanded speed display will illuminate to the left of center and if the current speed is above the set point speed, bars will illuminate to the right of center. The number of bar segments that illuminate is also dependent on the deviation setting.

The set point speed can be changed from the “Competition mode” by pressing the up and down arrow buttons. Pressing an arrow button once will change the set point speed by one tenth of a mile per hour. Pressing and holding an arrow button will cause the set point speed to scroll in one mile per hour increments.

The deviation can be changed by pressing the mode button once while in the “Competition mode”. The text line will display deviation X, where X is the current deviation value. Pressing the arrow buttons will cause the deviation to change in one mile per hour increments. The speedometer will go back to “Competition mode” five seconds after the last button is pressed or it will go to the “Normal mode” if the mode button is pressed before the five seconds expire.

“Calibration mode” can be entered only from “Normal mode” by pressing both arrow buttons simultaneously. The text line will display “Calibration X.X” where X.X is the current calibration value. This value will change the current speed displayed by the amount entered. The speedometer will go to “Normal mode” five seconds after the last button is pressed or when the mode button is pressed.

The pitot symbol indicates which pitot tube is used to display current speed and to indicate whether or not a pitot tube is clogged. Below is a list of the symbols and their meaning:

Port pitot tube used for display; Starboard pitot tube is functional: 

Port pitot tube used for display; Starboard pitot tube clogged: 

Starboard pitot tube used for display; Port pitot tube is functional: 

Starboard pitot tube used for display; Port pitot tube clogged: 

The set point, deviation and calibration values are stored in non-volatile memory. When the speedometer is powered on, it will recall the last valid values set.

Tachometer Operations

The tachometer displays current engine speed in revolutions per minute in both the analog and digital tach displays. The text line displays elapsed engine hours in one-tenth hour increments. The elapsed time will only increment if engine speed is over 400 RPM to prevent counting time when the ignition is on but the engine is not running.

Elapsed engine hours are stored in non-volatile memory and are recalled when the tachometer is powered on. Engine hours can not be set ahead or back.



2

Chapter 2

ENGINE OVERVIEW

It is the owners responsibility to check all of the items below to be certain all preparation steps have been completed before you use your boat. Checking these items periodically will soon become habitual. If leaks or other abnormal conditions are found, stop using the boat and contact your Correct Craft dealer to have the problem(s) corrected.

The following instructions are vitally important:

- Lift the top half of the engine box. Check to see if all the engine drain plugs are in. Make sure the hull drain plug down in the bilge and also the drain plug at the transom are installed.
- Look at all the hoses to make sure they are installed and the hose clamps are tight. Close the engine box and turn on the blower (switch is on the dash). Run the blower at least four (4) minutes. This helps to remove fuel vapors that might be down in the bilge before starting engine. Remember, if you have detected the presence of fuel vapors, do not start engine until source has been determined, any problems corrected and vapors removed.

Very Important!

- Check all gasoline line connections. These connections are located at the fuel tank, the Fuel Control Cell and the fuel injection system. All Correct Craft boats are equipped with anti-siphon valves on the outlet fittings of the fuel tanks to reduce the chance of fuel siphoning from the fuel tank if a fuel hose leaks or is severed.
- Fill the fuel tank and check for leaks. Check again for leaks after the engine has run for a few minutes.

Check list before starting:

- 1) **Engine oil level** - boat must be sitting level.
 - 2) **Transmission oil level** - boat must be sitting level.
 - 3) **Shifting linkage and detent in forward, neutral and reverse.**
 - 4) **Leaks** (water, fuel and oil).
 - 5) **Coolant level** (if the engine is freshwater cooled).
 - 6) **Operation of the throttle and transmission shift control.**
 - 7) **Battery condition.**
 - 8) **Visually inspect for any loose mounting fasteners.**
 - 9) **Verify the emergency engine cut off switch located by the throttle is fully functional.** Clip the safety lanyard securely to your body at all times you are driving.
- Once the boat is in the water, remove the inspection plate behind the engine box in the floor and visually check for water leaking at the stuffing box. This stuffing box must drip a moderate amount of water to properly lubricate the drive shaft. If the water is rapidly coming in, pull the boat out and have the

dealer adjust the stuffing box. There is a detailed instruction for this in the boat care section.

- Check to make sure there are no ropes, gear bags, arms/legs near the belts and pulleys of the engine. Severe injury can result by becoming entangled in the belts of the engine while it is running. Make sure the boat is deep enough in the water to supply the water intake with water to cool the engine. Move the throttle into the neutral position. This is in the “straight up” position.

WARNING: Before you start your engine, always ventilate the engine compartment by running the blower for four (4) minutes to remove any fuel fumes that may be in the bilge. This is especially important after repairing or refueling to check for fuel spills or leaks before starting the engine.

- Close the engine box before starting engine.
- Start the engine.

CAUTION: Do not continue to operate the starter for more than 30 seconds without pausing to allow the starter motor to cool off for five (5) minutes. This allows the battery to recover between starting attempts.

WARNING: In order to prevent personal injury to you or others, whenever the engine is running the engine box must be closed. Never operate the engine with the engine box open or while someone is in the area of an open engine box. Never open the engine box unless the engine is turned off and rotating parts are stationary and remain in a stationary position. Rotating machinery can cause injury and even death if an accident should occur. IT IS RECOMMENDED THAT ALL WORK ON THE ENGINE BE DONE BY TRAINED AND QUALIFIED SERVICE PERSONNEL.

During the warm up period, scan the gauges for correct operation of all the systems:

- Oil pressure 35-80 PSI (Approx..) at 2000 RPM
- Cooling water flow and water temperature 140-170 degrees
- Cooling water temperature for fresh water systems: 170 - 210 Degrees
- Volts should rise to around 13 - 14 volts or higher
- Idle RPM (600 - 700) in gear

CAUTION: Do not operate at high RPM's in neutral. Do not shift into forward or reverse at engine speeds above idle RPM's.

CAUTION: Do not operate engine without cooling water flowing through the water pump or the neoprene water pump impeller will become damaged, and severe engine damage may result.

If the fuel injected engine does not start:

- If the fuel filter has just been changed or if the fuel system has been run dry,

it will be necessary to cycle the ignition start button from the “stop” position to the “start” position several times until the fuel pumps build adequate pressure. The cycling of the ignition is necessary because the fuel pumps will run only 1-2 seconds when the ignition is turned on, unless the engine starts. The throttle control should stay in neutral during engine ignition. If the throttle is advanced, it is possible for the computer to think that the engine is flooded and initiate a “clear flood” condition which will shut off fuel to the engine and not allow it to start. The idle speed flare normally encountered on hot or cold start is perfectly normal. This is programmed into the computer. When the engine starts the idle speed will jump to approximately 1,500 rpm and quickly decrease to somewhere between 750 and 900 rpm.

- Check for gasoline and cooling water leaks on the engine.
- Check for cooling water circulation (look at the water filter at the rear port side of the engine for water movement).

Flooded engine

If your engine does become flooded, use caution when attempting to start the engine. Push in the transmission disengagement button at the bottom of the throttle arm and push the throttle to full throttle position. By pushing the button in, the shift linkage is disengaged and the transmission remains in neutral during the starting procedure. Run the starter until the engine starts.

To protect your investment, we suggest that you bring your boat back to your local dealer after 25 hours of operation for an inspection of the shaft alignment, stuffing boxes adjustment, and have the fuel system checked for leaks. This is not a free service. Follow Pleasure Craft Marine’s (PCM) recommendations in the maintenance section for additional service to the engine. (See Chapter 8) Consult your dealer to determine what charges will apply.

When the engine starts, move the throttle lever back until the engine is running about 2,500 RPM or less. Check the gauges for normal readings and let the engine run for a minute to burn the excess fuel. If the gauge readings are abnormal, shut the engine off immediately and contact your Correct Craft dealer. When the engine runs normally, check the engine for fuel, water and exhaust leaks. If there are leaks, these must be corrected before you continue.

NOTE: Read the “Notice to Dealer” sticker inside the engine box. These preparation checks have probably been completed by your dealer, but it is the owner’s responsibility to check these items. This will also help you become more familiar with your boat.

After your initial run:

- Check oil level in the engine
- Check the transmission oil level
- Check for leaks (water, fuel and oil)
- Engine frame bolts and mounts are tight
- Throttle and shift control operates correctly

WARNING: If the engine backfires when you try to start it, the problem may be more serious than flooding. DO NOT CONTINUE TRYING TO START THE ENGINE; CONTACT YOUR CORRECT CRAFT DEALER OR A QUALIFIED TECHNICIAN TO CORRECT THE PROBLEM. To keep on trying to start the engine under these conditions could cause engine damage or physical harm to you and those around you.

Break In Procedure

Make sure all your passengers are properly seated before starting the break in procedure. After the engine is thoroughly warmed up and you have driven the boat into a large open area, open the throttle to wide open until the maximum RPM's are reached. Do not exceed 5,000 RPM. Reduce the throttle to 2,800-3,000 RPM's and cruise at or below this speed for 1/2 hour. Reduce the speed to idle, open the throttle wide and operate at that speed for one minute; reduce to the previous cruising speed for a few minutes and repeat. Accelerating from idle speed to full throttle loads the engine and assists in seating the piston rings. This cycle can be repeated from time to time during the first five hours of operation, but full throttle should not be used for longer than 1-2 minutes.

WARNING: Follow these procedures only when conditions are such that you can drive the boat safely.

CAUTION Do not attempt to break in an engine by letting it idle at the dock.

GENERAL NOTES

The maximum RPM of the engine at full throttle under normal load conditions can be controlled by propeller pitch, diameter and design. It is essential that the propeller does not underload or overload the engine.

Propeller Overloading, resulting in low RPM's at wide open throttle will give poor performance, poor fuel economy and eventually result in engine damage.

Propeller Underloading, if operated with a propeller that has too little pitch or diameter, poor performance will result.

NOTE: Running your boat in shallow water can cause sand and silt to be pulled into the cooling system. This can create excessive water pump wear and

may clog the water passages in the engine. Heavy weed growth in the water can plug the raw water strainer and oil coolers and cause engine damage. There is a raw water filter located near the rear of the engine that filters the water before it goes into the transmission cooler and then the engine. Check this every time you use the boat to make sure it is not clogged.

3

Chapter 3

CAUTIONS AND WARNING LABELS

Cautions and Warning Labels

The following are the warning/information labels that should be on your boat. It is your responsibility to maintain the readability of these labels and to follow their warnings.

If your warning labels are not intact or are unreadable, please contact Correct Craft for a replacement set. These labels serve the vital function of warning you and your passengers of possible dangers and must remain in good condition on your boat.

NOTE: The warning / information label is listed next to each below.

Tow Pylon:

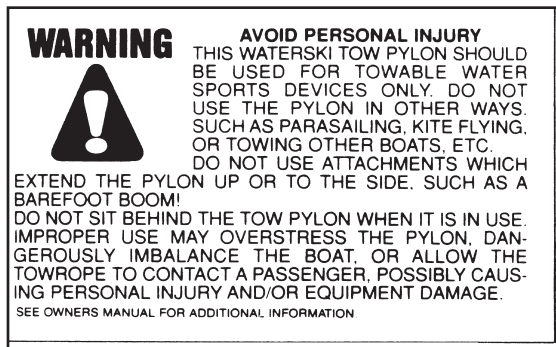

Flight Control Tower:

DANGER Failure to follow these guidelines can result in injury or death. Do not tow more than two persons at one time from this tow tower. The tow tower should only be used for waterskis, wakeboards, or recreational towables and not for parasailing, kite flying, or towing other boats ect. Do not add any attachments that are not installed by Correct Craft, Inc. Do not climb on, sit on, stand on, jump off, or dive off the tow tower. Never allow passengers to sit behind the towrope attachment point. Never allow loose towrope ends to dangle. Always be certain that all bolts are in place and tight before and during use. When the tower is up watch for low obstacles such as tree limbs, bridges or power lines. Before trailering your boat make sure that the tow tower is in the down position and properly secured.

Inside Engine box & on Fuel Tank

WARNING



LEAKING FUEL

**IS A FIRE AND EXPLOSION HAZARD
INSPECT FUEL SYSTEM REGULARLY**

SEE OWNERS MANUAL FOR ADD. INFO.

Water Strainer



CAUTION

**AVOID EQUIPMENT DAMAGE !
DO NOT LOSE SEAL RING WHEN
CLEANING WATER STRAINER
ELEMENT AND CANISTER. IF IT
IS LOST DO NOT OPERATE
ENGINE UNTIL THE SEAL RING
IS REPLACED.**

Fuel Fill

WARNING



**DO NOT USE GASOLINE
CONTAINING ALCOHOL.
ALCOHOL BLENDED FUELS
MAY CAUSE DETERIORATION
OF FUEL SYSTEM COMPONENTS.**

SEE OWNERS MANUAL FOR ADD. INFO.

Throttle Control

WARNING



AVOID PERSONAL INJURY

**UNINTENTIONAL SHIFTING OF THE TRANSMISSION
MAY OCCUR IF CONTROL LEVER IS BUMPED
OBEY WARNINGS ON THE DASH**

Transom Warning Label

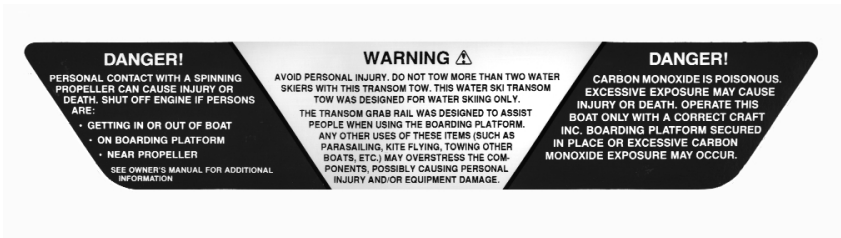

Dash Warning

DANGER Contact with a spinning propeller or excessive carbon monoxide exposure can cause injury or death. Shut off engine if persons are getting in or out of boat, near propeller or on boarding platform. Do not operate this boat without a Correct Craft Inc. boarding platform secured in place or excessive carbon monoxide exposure may occur.

WARNING Gasoline vapors can explode resulting in injury or death. Before engine startup, check engine compartment for gasoline vapors then run blower for four minutes. Run blower when below cruising speed.

Side Console Warning

Avoid personal injury Never run engine when the operator is not seated facing forward with hands on the controls. Leaking fuel is a fire and explosion hazard; inspect fuel system regularly and fix leaks immediately. Do not sit on seat backs, boat sides or engine box while engine is running. Do not make high-speed maneuvers in this boat. Do not stand on boat sides at anytime. To insure safe use and maintenance of this boat, read and understand the owners manual thoroughly. If you do not have a manual, contact: Correct Craft Inc. 6100 S. Orange Avenue Orlando FL 32809 (407) 855 - 4141 ski@skinautique.com

Avoid personal injury Always test the emergency engine shut off switch for proper function before operating the boat and never operate the boat unless the lanyard is securely attached to the driver.

4

Chapter 4

BOAT HANDLING GUIDELINES/SAFETY REGULATIONS

- Always observe the rules of the road and use common sense and courtesy on the water. If you think of it as driving a car, it becomes a bit easier. If a boat is coming towards you, you should pass that boat keeping it on your port (left) side.
- In a “crossing situation,” that is, another boat passing in front of you, if the boat is on your starboard (right) side, that boat has right-of-way.
- In an “overtaking situation,” the boat being overtaken (passed) has the right-of-way. The overtaking boat should pass on the port side of the boat being overtaken with a single blast of the horn. If you have to pass a boat on the starboard side for some safety reason, two blasts from the horn are required.
- When you encounter an unpowered boat like a sailboat or canoe, these boats ALWAYS have the “right-of-way”. If a sailboat is using a engine, it must follow the “Rules of the Road.”
- Do not demand the right-of-way, even if you are correct. The only correct move is to avoid a collision.
- NEVER OPERATE YOUR BOAT UNDER THE INFLUENCE OF ALCOHOL OR OTHER CONTROLLED SUBSTANCES!! This puts you and your passengers in danger as well as other boaters on the water.
- While the engine is running, and during the boat mooring, all occupants should be properly seated. Do not sit on engine box, seat backs, or gunnels, etc. You COULD fall overboard and be hit by the propeller. If you are sitting up in the open bow seating area, be careful not to obstruct the vision of the driver. Do not allow objects, arms or legs or any other body parts to hang over the bow or gunnels.
- Look carefully before turning, especially when you are turning around to pick up a fallen skier. Someone else may not be following the “Rules of the Road.”
- Keep a visual check for boats behind your boat. This is an area where accidents can happen very quickly.
- Do not stand while the boat is moving.
- Sit in the driver's seat while the boat is moving and INSIST that your passengers remain properly seated.
- Do not sit on the gunnels, deck, seat backs, boarding platform or engine box while the engine is running or while the boat is moving.
- Make sure you have a properly sized Coast Guard Approved PFC (Personal Flotation Device) on board and easily accessible for each person.

- There are no brakes to help you stop your boat. Boat speed, water current and wind can affect your ability to stop safely. The driver must use caution and sound judgment at all times to maintain control of the boat, especially to maintain a reasonable distance from all potential areas of danger. Slow down in all areas of potentially hazardous navigation and in all conditions of reduced visibility. Be alert for posted speed limits, swimming areas, no wake zones and other restrictions. Common sense plus courtesy add up to safety.

States have varying regulations regarding water sports activity. Check the local and state agencies in your area to determine laws regulating boating and water sports. These laws were written to protect boaters and water sports enthusiasts. Some states require that the driver have a qualified observer in the boat while pulling a skier. Learn and follow the laws where you will be boating. Correct Craft recommends that you have a qualified observer in the boat with the driver at all times when a person is skiing.

There are free pamphlets available regarding such things as Rules of the Road, Navigational Aids and Federal Requirements for Recreational Boats. Your dealer can supply these, as can organizations such as the United States Coast Guard Auxiliary and the U. S. Power Squadrons. Check with your state's boating publications. Regulations vary from state to state.

5

Chapter 5

C A R E

There are some engine maintenance functions that are best performed by your dealer. Maintenance items that can be done by you or your dealer are listed below. We suggest that you familiarize yourself with these even if you have your dealer service your boat.

The old adage “An ounce of prevention is worth a pound of cure” applies to your boat. Here are some tips that will help keep your boat in good running order and in good condition.

1. Read the instructions regarding your engine very carefully.
2. Check for fuel line leaks every time you use the boat.
3. NEVER start your engine if gasoline odor is present. Gasoline fumes are highly explosive. Before starting your engine, open the engine box, inspect the engine compartment for gasoline fumes and operate the blower for at least four minutes. Your boat has two struts that hold the engine box up. Run your blower when operating at slow speeds. If fuel vapors are present, do not start the engine. Check all hoses and fittings to determine the source of the vapor. Make the necessary adjustments or take the boat to your local dealer to eliminate the fuel vapor.
4. When servicing the ignition switch or any wiring, always disconnect the battery cables from the battery.
5. Check for water circulation when the engine is running. Exhaust should contain steady flow of water. In closed cooling systems, make sure the coolant in the cooling system is at the proper level.

BILGE PUMPS

Check your bilge pumps often to make sure they are operating efficiently. There are two bilge pumps; one is at the rear of the boat near the rudder and the other is under the floor by the ski pylon. To keep the pumps from getting clogged, remove any debris that you find in the bilge. Wash the bilge with a good biodegradable household detergent or a bilge cleaner available at a marine supply store. Rinse with water with your bilge pumps running. If either pump seems to lag, remove the top of the pump from the base and check the impeller to make sure there is no debris stuck inside. See your dealer if there is still a problem with either pump.

PROPELLER Here are a few tips for the installation of the propeller.

CAUTION: A propeller can be very sharp so be careful when you handle it. It's a good idea to wear a pair of protective gloves when handling any propeller.

1. Before placing the propeller on the shaft, take a look at the keyway on the shaft and in the propeller. Make sure the key slides freely in the shaft keyway as well as the propeller keyway. You may need to file the flat sides of the key and the keyway to remove burrs. Rotate the shaft until the keyway is “up”. Place the key in the shaft keyway. Rotate the propeller so the keyway in the propeller is aligned with the keyway on the shaft. (See illustration.) Once aligned, push the propeller onto the shaft. You'll hear a solid “thunk” as the propeller is seated. The propeller will only slip on in one direction.

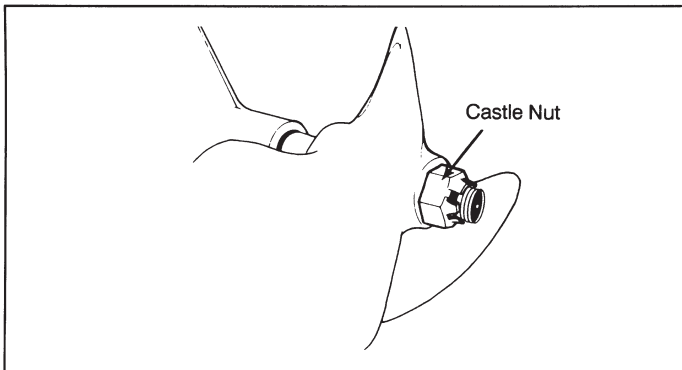
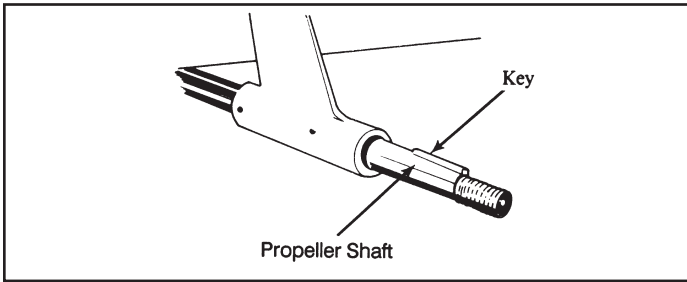

2. Put the castle nut on the shaft and wrench tighten.

3. When the castle nut is tight, look for the cotter pin hole and insert the stainless steel cotter pin through the shaft. (see illustration). With a light tap, drive the cotter pin down through the slot and hole so that its rounded top rests snugly against the hole. Bend the loose ends of the cotter pin back against the shaft with a pair of pliers and tap them lightly to secure.

To remove propeller, remove the cotter pin. Loosen the castle nut to the end of shaft. Do not completely remove castle nut. Use a propeller puller available at most marine supply stores to remove the propeller. Use a new cotter pin when you replace the prop (see illustration).

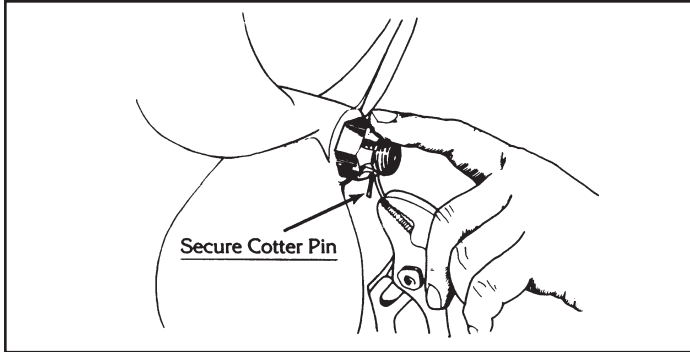

A FINAL CAUTIONARY NOTE: BE CAREFUL HANDLING YOUR PROPELLER. A SHARP PROPELLER CAN CAUSE A PAINFUL CUT!!

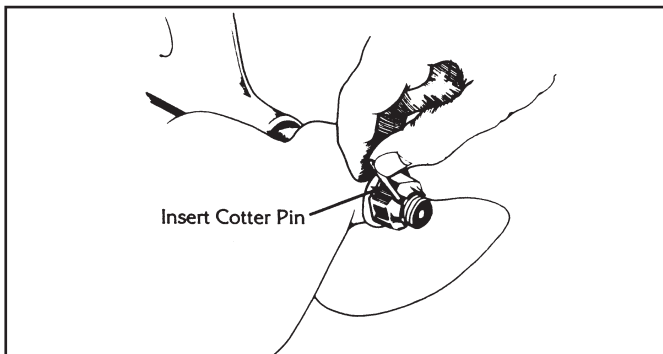

PROPELLER SHAFT STUFFING BOX

The stuffing box is designed to prevent water from coming through the through-hull fittings. These are found on the propeller shaft where the shaft goes through the hull and where the rudder comes up through the bottom of the boat. These devices contain a lubricated fibrous packing that acts as a seal.

The propeller shaft stuffing box should be checked frequently (with the engine off) for excessive leakage other than a few drops per minute. This rate is acceptable and expected. To inspect the shaft stuffing box, remove the inspection plate in the floor behind the engine box. If you view a steady stream of water or an excessive drip rate, you need to tighten the stuffing box. If tightening is required, follow the procedures with careful attention.

1. You will need two pipe wrenches, twelve inches of .032 gauge stainless steel safety wire, flat blade screw driver and wire cutters. Remove the engine box. Remove the floorboard between the engine box and the stern seat.

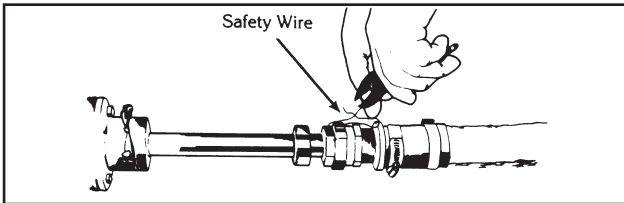

2. Cut and discard the safety wire (this wire prevents the packing gland nut from loosening.) See illustration.

3. Hold the gland nut (large nut) with a pipe wrench and loosen the locking nut with another pipe wrench. See illustration.

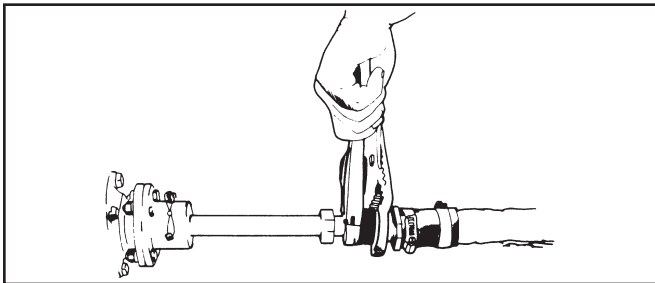

4. Now, **HAND-TIGHTEN** the gland nut until the dripping slows down to about 6 - 10 drips per minute. See illustration.

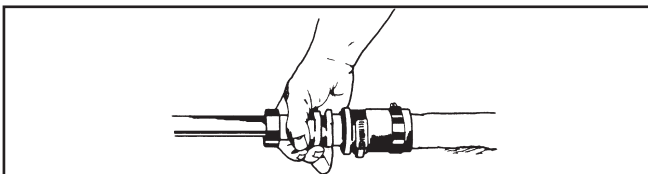

- Using wrenches as in step three, re-tighten the locking nut against the gland nut. Make sure that it is VERY TIGHT. If you still experience leakage, consult your dealer.
- Loosen one of the hose clamps at the rear of the assembly. Rotate the assembly until the safety wire eyelet is on top, and retighten the hose clamps.

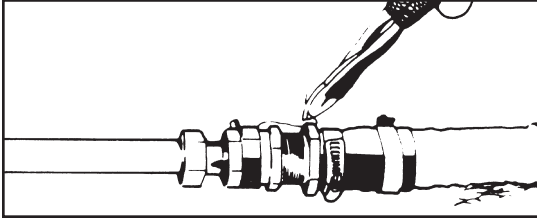

- Replace the safety wire as shown in the illustration.

NOTE: BE SURE TO REPLACE THE SAFETY WIRE. THIS IS VERY IMPORTANT. USE A STAINLESS STEEL SAFETY WIRE OF AT LEAST .032 GAUGE.

Through-Hull Fittings

All fittings that actually pass through the hull on the wetted surface are caulked in. These are not serviceable and should not be tampered with.

Oil Drain System

The first oil change should be done after 25 hours. All the rest of the oil changes should be done after every 50 hours. There is a drain hose attached to the bottom of the oil pan with a small plug screwed into the loose end of the hose. Remove the hull drain plug and stick the end of the drain hose through the drain hole in the bottom of the boat.

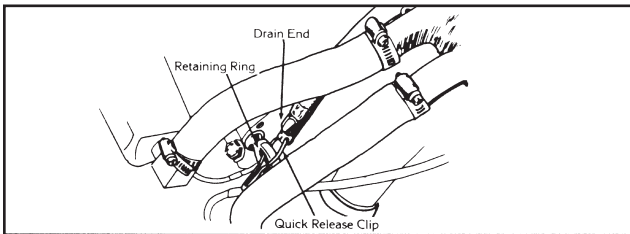

Make sure there are no kinks or sharp bends in the hose. Remove the plug at the end of the hose and drain the oil into a container under the boat.

The engine will drain most efficiently when the oil is warm. Allow several minutes for the oil to settle and drain.

NOTE: BE SURE THE ENGINE IS OFF WHEN YOU ARE DRAINING YOUR OIL. (See Chapter 8 for step-by-step instructions)

Salt Water Boating

IF YOU USE YOUR BOAT IN SALT WATER, FLUSHING YOUR ENGINE AND COOLING SYSTEM IS A MUST. Flushing the system by running the boat in fresh water is a good way to flush the engine, but it must be done immediately. If this is not possible, Correct Craft offers an optional fresh water flush kit. The relief valve in this fitting prevents excessive water pressure from being applied to your engine. We strongly recommend the use of this system for boats that are used in salt water.

Battery Maintenance

WARNING: The battery cables should be removed from the battery when the boat is placed in storage, on display, or in transit. This will eliminate the possibility of the engine accidentally starting without a supply of cooling water and damaging the engine.

Here are several suggestions for the care and cleaning of your marine battery:

- DO wear eye protection and rubber gloves when working on or around batteries.
- DO take care when connecting or disconnecting a battery charger. Be sure the charger is turned off and unplugged from power source when you clip on/off the connecting clamps. Make sure you have a solid connection with the charging clamps. Poor connections are common causes of electrical arcs which can cause an explosion. Follow the instructions.
- DO use a voltmeter or hydrometer to check the battery charge condition.
- DO NOT smoke or bring a flame near a battery at any time.
- DO NOT have your head directly above a battery when making or breaking electrical connections.
- DO NOT use a metal object to spark between battery posts to check if the battery is charged.
- DO NOT make or break electrical circuits at the battery terminals; a spark usually occurs when a live circuit is opened or made.

To clean your battery, remove and wash down the battery case with a diluted ammonia or baking soda/water solution to neutralize the acid, then flush with fresh water. Keep the fill/vent caps tight so the neutralizing solution does not get into the battery cells.

The electrolyte level should be checked every 30 days. Add distilled water to maintain the level between the top of the plates and the bottom of the fill/vent cap. Do not overfill and remember that batteries contain sulfuric acid which can cause severe burns.

Winterizing Your Boat

Winter storage procedures vary depending on climate, type of storage and length of storage. Check with your dealer/storage facility manager for their advice on what works best in your climate.

When storing your boat up on a rack system, it is important that the racks adequately support the hull bottom.

If you do not have a trailer, then a cradle should be used that takes into account the even distribution of weight.

If you do not have a dealer or marina nearby and must arrange winter storage yourself, contact your regional warehouse.

If you use a mooring cover, DO NOT put it on when the interior of the boat is wet and/or hot. It will trap moisture that may lead to mildew on the carpet and/or vinyl. Make sure your mooring cover allows air to circulate, even if you have to leave a portion of the cover off.

The raw water filter bowl remains full of water even after the rest of the raw water system has been drained. To properly winterize your boat, the filter bowl should be removed and emptied. Be careful to not lose the rubber O-ring that seals the bowl to the cap. If the water is not removed, the bowl could be damaged by freezing and cause overheating problems during the next season.

Check For Water In Your Fuel System

A small amount of water left in the system for several months can result in damage. If you are storing your boat for the winter, it is a good practice to remove any water in the fuel system.

The Fuel Control Cell can be drained by removing the drain plug at the bottom of the canister. Loosen the incoming fuel hose to provide an incoming air source. Clamp the incoming fuel line to minimize the amount of fuel that may drain. Once the canister is drained, coat the threads of the drain plug with a fuel resistant pipe thread sealer, then replace and tighten the plug. Reconnect the fuel hose, and tighten the hose clamp. It is imperative that the threads be sealed properly to avoid a possible fuel leak.

Check your Fuel Control Cell once each year for signs of water in the canister. If it appears there is an undue amount of water build-up in the canister, see your Correct Craft Dealer for service.

An empty fuel tank can accumulate water inside by repeated cycles of condensation on the inner surfaces of the tank. If the fuel tank is kept at about 3/4's full during storage times, much less water can condense, limiting the build up of water in the fuel tank.

We recommend filling the tank to 3/4's full at the most during storage to eliminate the possibility of fuel expansion caused by temperature changes.

This minimizes overflow of fuel from the fuel vent. Not only can this overflow be hazardous, but it will also adversely affect decals and pin striping on the boat.

Always allow room in the tank for fuel expansion caused by temperature differences. Add a fuel stabilizer that slows down the rate of fuel decomposition. You can purchase this material at most marinas or auto supply stores. Add the stabilizer to the tank and then fill the tank to approximately 3/4's full.

Run the engine to circulate fuel throughout the system. This will help keep gasoline from degrading and causing problems in the fuel system. Remember to always follow the fuel stabilizer manufacturer's recommendations for proper mixing.

Note: GASOLINE EXPANDS WHEN THE TEMPERATURE INCREASES. NEVER STORE YOUR BOAT WITH MORE THAN ABOUT 3/4'S OF A TANK.

Gelcoat Care

Regular maintenance is the key word to keeping your hull and deck surfaces in good-looking condition. Some of the things that will affect your boats finish are sun exposure, residue from trees or minerals in the water.

To help maintain the shine of your boat, wash the hull with a mild biodegradable detergent after each use. This will help to remove any debris and waterborne materials that are on the hull. Use a soft sponge or towel and dry with a chamois cloth to prevent water spots.

Wax the hull sides and deck regularly. Waxes and polishes are available at a marine supply stores. Read the directions on these products carefully before you use them.

The hull bottom is an especially important area to keep clean since any build-up of water scum and algae will increase create drag and reduce the boat's efficiency. If you must leave your boat in the water, there are marine cleaners available to remove algae build-up on your hull. Some of these can be caustic. Pay special attention to the cautions on the label of these coatings. Ask your dealer for advice on which work best in your area.

If your boat's gelcoat develops a chalky look over a period of time due to exposure to sun, there are gelcoat buffing and polishing compounds available at marine supply stores. DO NOT use common household scouring pads or powders.

If you will be keeping your boat in the water for ANY period of time, we suggest that the wetted surface of the hull be painted with an epoxy paint formulated for blister protection.

Correct Craft offers a 90-day limited warranty against gelcoat defects to the

original purchaser. For more information, see the complete warranty at the back of this manual.

Teak Care

Teak is a unique wood used for marine applications. It is an open cell wood that is highly resistant to the dry-rot associated with many other woods and is also highly resistant to marine organisms. Don't coat the teak on your boat with any kind of varnish or polyurethane coatings. There are several teak oils available at marine supply stores.

When the teak on your boat is new, it has a medium brown color. After a period of time, exposure to the elements will cause it to turn a weathered gray color. If you want to refinish the teak, we suggest you purchase a teak cleaner from a marine supply store. Follow the instructions on the teak refinishing bottles. You should use these products in an open space with eye protection, rubber gloves and good ventilation. Be very careful to avoid spilling these products on any part of your body.

Metal Care

Keep all metal work rinsed and wiped dry. Periodically polish it with a commercially available metal polish.

Glass Care

Your windshield, mirrors and gauge faces all deserve the same attention as the other parts of your boat. Clean them often with commercially available glass cleaners.

Vinyl Maintenance and Cleaning

Correct Craft has selected the finest marine grade vinyl for your Nautique. It is important to keep it clean at all times. There are some substances that will stain the vinyl if you leave them on for even a short period of time. Remove any contaminant and clean the area immediately. Do not use 409 Cleaner or any Silicone based products. Certain household cleaners, powdered abrasives, steel wool and industrial cleaners can cause damage and discoloration. Do not use these cleaners. Dry cleaning fluids and lacquer solvents should not be used.

Use the chart below to clean some of the common stains:

COMMON STAINS AND STEPS TO TREAT:

	Step #1	Step #2	Step #3
Chewing gum	D	A	D then A
Eyeshadow	E	B	E then B
Engine oil	B	B	B
Spray paint	C	B	B
Mildew or wet leaves *	D	B	A
Shoe polish *	A	B	
Yellow mustard	D	B	
Oil based paint (fresh)	D	B	
Oil based paint (dried)	A	B	
Suntan lotion *	D	B	
Tar/Asphalt	A	B	
Lipstick	A	B	
Latex paint	A	B	
Crayon	D	B	
Ketchup	A	B	
Grease	D	B	
Ball-point ink *	E	B	
Permanent marker *	E	B	
Coffee, tea, chocolate	B	B	

A. Medium-soft brush, warm soapy water/rinse/dry

B. Meguires Quick Clean #52

C. One(1) tablespoon ammonia, one fourth (1/4) cup hydrogen peroxide, 3/4 cup water
rinse/dry

D. Wipe or scrape off excess (chill gum with ice)

E. Denatured Alcohol/rinse/dry

After all cleaning methods, rinse well with water.

*Suntan lotion, shoe polish, wet leaves and some other products contain dyes that stain permanently.

TUNABLE RUDDER

The Tunable Rudder is designed to offer easy adjustment of steering. This system utilizes a composite tuning foil which is located at the upper aft corner of the rudder blade. To adjust the foil a Phillips head screwdriver will be needed. Loosen the two machine screws located in the relief slots of the tuning foil.

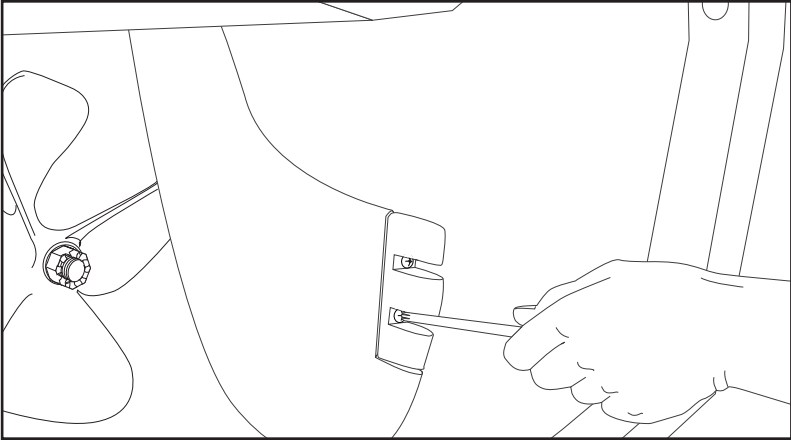

Loosening Tuning Foil

If the boat is pulling left, rotate the foil to the left and tighten screws.
If boat is pulling to right, rotate the foil to the right and tighten screws.
Always remember that movement of the trailing edge of the foil to one side will cause the steering to pull to the opposite side.
Note: After each adjustment, test run and adjust again if necessary.

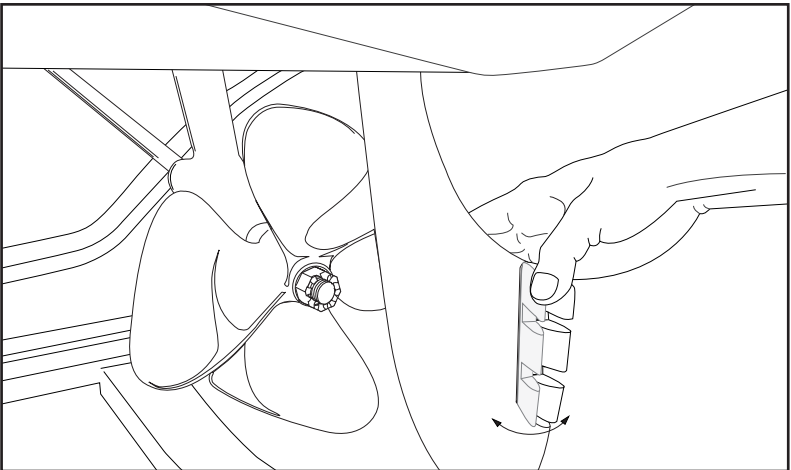

Adjusting Tuning Foil left or right

6

Chapter 6

TRAILER/TRAILERING

Hitch

If you don't already have a trailer hitch installed on your vehicle, go to a reputable installer to have the proper size hitch installed. Always use a hitch rated with the appropriate capacity to match the trailer and boats gross weight.

WARNING: Do not attempt to tow more than one trailer at a time behind your vehicle. Attempting to tow an additional trailer will adversely affect the trailer tongue weight and loss of vehicle control and/or injury or death may occur.

CAUTION: Never install a bumper mounted hitch on your vehicle. Always use a hitch that is attached to the frame of your vehicle.

Wiring

The trailer requires wiring from your vehicle to the trailer lights. This can usually be done by the hitch company.

Security

There are several locking devices available at marine supply stores that will aid in securing your boat whether or not it is attached to your vehicle.

Towing Your Boat Consult this checklist prior to trailering your boat.

- Check wheel lug nuts for tightness.
- Be sure the trailer tongue is securely on the hitch and the safety chains from the trailer are secured to the vehicle.
- There needs to be a cable or strap securing the bow eye of the boat to the trailer. Make sure this is tight and is secure.
- Be sure the trailer electrical connector is plugged in. Allow sufficient slack for cornering. Check brake lights, turn signals, emergency flasher and running lights.
- Be sure your gear inside the boat and seat cushions can not shift or fly out of the boat during trailering.
- Make certain the walk-through door of the windshield is closed and latched while the boat is being trailered.
- If you are using any sort of water "ballast" system to add weight to the boat, make certain it has been drained before you put the boat on the trailer. These systems can adversely affect the tongue weight of the

trailer. Your boat is not designed to carry exceptionally heavy loads. This can adversely effect the proper balance of the boat/trailer combination and cause tire failure and/or loss of control.

- If your boat is equipped with a bow winch, make sure that the boat is properly located on the trailer and the winch strap/cable is tight.
- Make sure the boarding platform bracket pins are in place before trailering.

Long Trips

Each time you stop on a long trip, check the following:

- Tightness of the wheel lug nuts and the bearing lubricant.
- Make sure the boat is still positioned snugly against the bow stops.
- Examine the hitch connection to be sure it is firmly attached and the safety chains are securely fastened.
- Make sure that all trailer lights are still functioning properly.
- Re-examine the contents of your boat to insure that no items such as life jackets or other gear have shifted and may fly out while you are on the road.

7

Chapter 7

CORRECT CRAFT LIMITED WARRANTY

The Correct Craft warranty is backed by a family tradition of boat building experience since 1925.

Lifetime Limited Warranty

Correct Craft, Inc. warrants to the original retail purchaser of each new Correct Craft boat that, under normal authorized use, the deck, hull and stringer system shall remain free from structural defects for as long as the boat is owned by the original retail purchaser.

Transferable Lifetime Limited Warranty

In addition, Correct Craft offers a transferable Lifetime Limited Warranty covering the deck, hull and stringer system as detailed above. This policy may be transferred (for a nominal fee) to the second (2nd) purchaser during a period of five (5) years from the date of delivery to the original retail purchaser. See your local dealer for details.

Exception: The “Lifetime” and “Transferable” warranties do not cover the gelcoat nor any other components fastened or applied to the hull or deck. Gelcoat discoloration, blisters or bubbles and cracks are not considered structural defects.

Gelcoat Ninety (90) Day Non-Transferable Warranty

Correct Craft, Inc. warrants to the original retail purchaser that each new Correct Craft boat will, under normal authorized use, be free of gelcoat defect for a period of ninety (90) days from the date of delivery to the original retail purchaser.

One (1) Year Non-Transferable Warranty

Correct Craft, Inc. warrants to the original retail purchaser that each new Correct Craft boat will, under normal authorized use, be free of defect in material and workmanship for a period of one (1) year from the date of delivery to the original retail purchaser.

Exceptions

The warranty shall not apply to:

- 1.) Any Correct Craft boat which has been used at any time for commercial or racing purposes, as a demonstrator or in a promotional program, ski school or ski show.
- 2.) Upholstery, canvas or glass, unless defect is noticed at time of delivery and notification is given to Correct Craft, Inc. within 10 days thereof.
- 3.) Underwater gear which includes propeller, propeller shaft, strut, rudder and fins.

- 4.) Chrome plated, anodized or aluminum finished or colorfastness of finishes.
- 5.) Damage or malfunction of a boat resulting from improper maintenance, misuse, negligence, improper or inadequate trailering or cradling of boat.
- 6.) Any addition, modification or repair of the boat, or any component thereof, by any person or party other than Correct Craft, Inc., or any defect or product failure caused by or arising out of any such addition, modification or repair. Generally, with respect to any product liability issues, Correct Craft should not be held liable for product defects caused by substantial changes to the boats by the buyer or any third party not authorized by Correct Craft, Inc.
- 7.) Engines, parts or accessories, controls or other products not manufactured by Correct Craft, Inc. which Correct Craft may use or sell in connection with Correct Craft boats. To the extent that these parts are warranted, purchaser must look to the manufacturer warrantor thereof for such warranty and remedy thereunder for defects in materials or workmanship.
- 8.) Any and all consequential damages including, but not limited to, cost incurred for haul-out, launching, towing, and storage charges, telephone or rental charges of any type, inconveniences, or loss of time or income.

Any defect or damage covered by this warranty shall, at the discretion of Correct Craft, Inc., be repaired free of charge at an authorized dealership. Repairs will be warranted only for the remainder of the original warranty period. Transportation and/or labor to and from the point of repair will be the responsibility of the owner.

THERE ARE NO WARRANTIES WHICH EXTEND BEYOND THE DESCRIPTION OF THE FACE HEREOF. THIS LIMITED WARRANTY IS EXPRESSLY MADE IN LIEU OF ALL OTHER EXPRESSED WARRANTIES. DURATION OF ANY IMPLIED WARRANTY OR MERCHANTABILITY OR FITNESS FOR A PARTICULAR PURPOSE OR OTHERWISE, SHALL BE LIMITED TO AND COINCIDENT TO THE DURATION OF THESE EXPRESSED WARRANTIES. UNDER NO CIRCUMSTANCES SHALL CORRECT CRAFT, INC. BE LIABLE TO THE PURCHASER OR ANY THIRD PARTY FOR LOSS OF PROFITS OR OTHER DIRECT OR INDIRECT COST, LOSSES OR CONSEQUENTIAL DAMAGES ARISING OUT OF OR AS A RESULT OF DEFECTS IN PRODUCTS HEREIN ABOVE WARRANTED.

Some states do not allow limitations on how long an implied warranty lasts, so the above limitation may not apply to you. Some states do not allow the exclusion or limitation of incidental or consequential damages, so the above limitations may not apply to you. This warranty gives you specific legal rights and you also have other rights which may vary from state to state.

This warranty is expressly conditioned upon the completion and return of the warranty registration card to Correct Craft, Inc. Although not obligated to, and without creating such an obligation, this will enable us to notify you of any necessary performance or safety modifications to your boat and to verify ownership in case a warranty claim is filed on your boat.

Procedure

In the event your Correct Craft boat has a claim covered by this warranty, the following procedure shall be followed to secure performance or warranty obligations:

- 1.) Notify the selling dealer within 30 days after the discovery of any claimed defect, or 10 days from the day of delivery in the event of a claimed defect involving upholstery, canvas or glass.
- 2.) You may be required to transport the boat, at your expense, to an authorized dealership for their inspection and/or repair.
- 3.) Correct Craft, Inc. reserves the right to require further evaluation and/or information regarding a warranty claim against a boat prior to its repair as well as designate the place of repair.

Correct Craft, Inc. reserves the right to make changes in prices, color, specifications, equipment, options, materials, hull, decks, and/or discontinue models at any time (without notice) and shall be under no obligation to equip or modify boats built prior to such changes.

Correct Craft, Inc., 6100 South Orange Avenue, Orlando, Florida 32809, 407/855-4141, FAX 407/851-7844. E-mail address: ski@skinautique.com
Effective 2001 Model Boats.

8

Chapter 8

ENGINE MAINTENANCE

The engine in your Nautique will need to be checked and serviced at regular intervals. You may be able to do some of the maintenance while a Correct Craft dealer or PCM certified mechanic should be used for the more intensive work.

WARNING: The maintenance instructions given in this manual are to be performed with extreme caution. Improper or careless actions on the part of the person performing maintenance on your boat or engine could result in severe personal injury, property damage and or death. Before performing any operating or maintenance procedure covered in this manual, be certain to read the entire manual to be certain you fully understand the procedure. Proceed only when you determine that you may do so in complete safety. Contact your Correct Craft/PCM dealer for any maintenance service which you are unable to perform in complete safety.

This manual includes operational instructions and maintenance schedules that are usually required in normal service. Do not attempt any repairs that are not specifically covered in this manual. Strict compliance to the recommendations for lubrication, maintenance, operation etc., will provide you superior performance and dependable service. Improper maintenance or use of unsuitable products will affect your warranty coverage.

PCM Delivery Inspection

Before you pick up your boat from your dealer, speak with them to make certain the following items have been checked. Items to be checked include, but are not limited to:

- Engine oil level
- Engine timing
- Tension of all belts
- Idle speed
- Drain plugs in engine
- Water lines
- Throttle control operation
- Alternator output
- All lubrication points
- Prop shaft alignment
- Battery charge
- Prop size and nut
- All fuel/oil lines

- Exhaust hoses/clamps
- Water/exhaust leaks
- Hull drain plugs

Service For Your PCM Engine

Your PCM engine was manufactured by PCM from the finest materials available and distributed through your Correct Craft dealer who is in the best position to provide you with proper service. Your Correct Craft dealer is your direct contact with PCM authorized service. Your dealer has the necessary tools and training to properly handle your normal service requirements as well as supply you with the parts, service and information you may require.

If your Correct Craft dealer is unable to provide you with the parts, service or information you require, they will contact PCM directly on your behalf. The PCM Service Department depends on specific and accurate information in order to aid your dealer to respond to your service and parts needs. Your dealer has been trained to provide this information.

PCM facilities are dedicated to the manufacturing and distributing of the finest marine engines available. PCM does not repair engines or engine components at their locations.

If you are anticipating a trip to an area where you are not aware of the location of a PCM servicing dealer, contact PCM customer service department prior to leaving for the location of a PCM dealer where you may be traveling. For service and/or parts literature, contact your Correct Craft dealer or:

PCM
P.O. Drawer 369
Little Mountain, SC 29075

Service Information Request When you contact your dealer or PCM for service or parts information, please include the following:

- Your name, address and phone number.
- Engine and transmission serial and model numbers.
- Date purchased.
- Name of selling or servicing dealer.
- Hull number.
- Number of hours on the hour meter.
- Date of previous correspondence.
- All other pertinent information necessary to allow them to respond properly.

Engine / Transmission Identification

The engine model number and serial number is in different locations, but can be found on one of these locations:

- On a plate bolted to the intake manifold.
- On the port valve cover attached to the inside vertical surface at the front.
- On the top and at the front of the port valve cover.
- On a plate bolted on the intake manifold on the port side.
- On the port valve cover just aft of the flame arrestor.

MAINTENANCE

Selecting Engine Oil

The engine crankcase oil should be selected to give the best performance in your climate and operating conditions. During the hot summer months, use an oil that has adequate lubrication under high operation temperatures. In cooler weather, use an oil that will allow easy starting at the lowest temperature you are likely to encounter. Make note of this when you are changing oil so you select the right oil for your conditions.

We recommend SAE 40W40 of any good grade automotive oil of correct viscosity which has an A.P.I. classification of “SH” for use in all PCM engines. Multiple viscosity oils such as 20W40 and 20W50 which meet the A.P.I. classification “SH” can be used during cold weather operation. Use the following air temperature guidelines:

Above 50 degrees F.....40W40

32 - 50 degrees F.....30W30

Below 32 degrees F.....20W50

Engine oil and filter must be changed after the 25 hour break-in period. After this initial oil change, you should change the oil after every fifty hours of operation.

Changing the Engine Oil

These instructions are for changing the oil while the boat is on a trailer.

CAUTION: All engine waste fluids are considered to be hazardous wastes. Be certain these waste fluids are properly and legally disposed of in order to avoid polluting and or possible citation by the authorities.

CAUTION: Do not operate the engine without cooling water flowing through the water pump or the neoprene water pump impeller will be damaged. The best way to insure adequate water flow when the boat is out of the water is to install a Correct Craft Water Flush. Be aware that some methods of providing water to the engine can allow water to be injected into the combustion chamber; possibly resulting in severe engine damage.

Allow the engine to warm up to operating temperature by running it slowly at idle speed. Watch the water temperature gauge to prevent overheating.

Never start the engine with the engine box open.

- Start engine and allow engine to warm up to normal operating temperature. Turn the engine off.
- Remove the bilge drain plug and insert the oil drain hose down through the drain hole.
- Remove the fastener at the end of the hose and drain the oil into a suitable container.
- Position a suitable container under the oil filter in the bilge and remove the oil filter from the engine. Be careful not to spill oil into the bilge. Spilled oil must be cleaned up and disposed of in a safe and legal manner.
- Fill a new oil filter 3/4 full by carefully pouring oil into the threaded hole in the center of the filter. This initial filling of the filter reduces the time the engine operates without oil flowing through the oil passages when you start the engine.
- Lubricate the oil filter gasket with engine oil and install the filter until the gasket lightly contacts the block surface. Tighten the filter an additional 1/4 turn from this point.
- Fill the engine with the proper type and grade of oil for your operating conditions. This should be about 4 quarts.
- Close the engine box. Make certain there is a supply of water to the engine water pump. Start the engine and let it run for one minute. Turn the engine off, lift the engine box and inspect the engine for oil leaks..
- If leaks are present, shut off the engine immediately and repair any leaks. Repeat the previous step.
- Recheck oil level. If oil level is low, bring up to full mark by adding oil in small amounts.
- Dispose of oil, filter and cleaning materials in accordance with the applicable laws.

Engine Crankcase Capacity/Level

CAUTION: The dipstick should be considered the device that insures the proper oil level. Unless a major variation between oil capacity listed in the specifications and dipstick readings exist, always use the dipstick to determine the proper oil level of your engine.

Make sure the boat is level when you check the oil level.

NOTE: BE CERTAIN THE PROPER AMOUNT OF OIL IS IN THE CRANKCASE AT ALL TIMES. IF THERE IS ANY QUESTION, CONTACT YOUR CORRECT CRAFT DEALER.

It must be emphasized that every engine, particularly during the break-in

period, uses a certain amount of oil to act as a lubricating and cooling agent. The initial rate of consumption will gradually decrease until it stabilizes after approximately 100 hours operation.

The engine oil level should be checked frequently and oil added when necessary.

When you check the oil level, the engine should be warm. After you shut the engine off, wait one minute to allow oil to drain down from the upper engine cavities to the pan or you will get a false reading. Make sure the dipstick is all the way down before you pull it out to read the oil level.

The space between the “Full” and “Add” marks represents one U.S. quart. It is not necessary to add oil unless the level is near the “Add” mark. **DO NOT ALLOW THE OIL LEVEL TO FALL BELOW THE ADD MARK!**

Raw Water Strainer

Cooling water comes through the bottom of the boat via a through-hull fitting. This water passes through the strainer, transmission oil cooler, the engine and then out the exhaust. It is important to always check this filter visually before you use the boat. This can be done during the four (4) minute blower operation. There is a fine wire screen inside the bowl that collects lake grass and other debris. If you see this sort of debris in the strainer, unscrew and remove the bottom of the strainer. **Be careful not to lose the O-ring seal.** Lift the screen out and clean the trash off the screen. Dump out the trash that may be in the bottom of the strainer bowl. Replace the screen AND THE O-RING gasket and re-install the bowl. Do not tighten more than hand tight. Remember to close the engine box before you start the engine.

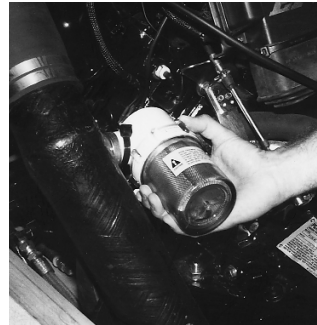

Water Strainer

IMPORTANT: This should always be done before you use your boat. Debris in the strainer restricts the normal flow of cooling water to your engine, and may cause overheating and possible engine damage. The strainer bowl retains water, even when the raw water system has been drained. This water needs to be dumped out to properly winterize the boat. If the water is not dumped out, the bowl could be damaged by freezing water. The damaged bowl could cause overheating during the next season and possible engine damage.

Transmission Cooler

Periodically check the transmission oil cooler water inlet. To remove the hose, loosen the hose clamp and twist the hose off. Look at the honeycomb-like filter for any debris that may have gotten past the raw water strainer. Use needle nose

pliers to remove any debris before reassembly.

Replacing Fuel Filter

WARNING: Be careful not to spill fuel; Do not proceed if fuel is spilled. Gas vapor built up is explosive and could cause severe personal injury, property damage or even death. Do not smoke while servicing fuel filters or other fuel system components. Contact your Correct Craft/PCM dealer for further assistance.

Fuel filters are standard on all PCM electronic fuel injection engines as a part of the Fuel Control Cell. The FCC has instructions on the bowl. Follow these instructions and cautions when replacing the fuel filter element.

Prolonged Storage

If you need to store your boat for an extended period of time we suggest you use a fuel stabilizer such as STA-BIL to prevent the formation of gum and varnish in the fuel system. Add the recommended amount to the fuel and run the engine for a minimum of ten minutes to allow the mixture to enter the fuel system. The following season should be trouble free. Call (800) 621-1251 for more information.

NOTE: DO NOT re-use old fuel filter components; always replace with a new fuel filter and gasket.

Exhaust System

The exhaust system should be periodically inspected for leaks to prevent water and/or exhaust gases from getting into the boat. Check to make sure the exhaust “flapper” at the transom is securely attached and working properly. All defects discovered must be fixed right when they are discovered to insure safe operation.

WARNING: Removing hoses from the engine while the boat is in the water may allow water to enter the bilge. This could sink the boat. Remove hoses only if you have determined you are doing so safely.

WARNING: Never use your boat without the boarding platform attached. The boarding platform is instrumental in channeling engine exhaust gasses, including carbon monoxide, away from the stern. Failure to have the boarding platform properly installed could result in excessive carbon monoxide levels in the boat. Excessive carbon monoxide levels can cause injury or death. Never operate this boat without this specially designed platform in place.

PCM Transmissions

The transmission fluid level should be checked frequently and fluid added if necessary. The fluid must measure between the two marks (FULL & LOW) on the dipstick.

Fluid type

All PCM transmissions use DEXRON type transmission fluid

This fluid should be changed once every year. The transmission holds approximately 2 quarts of fluid.

CAUTION: Do not operate the engine without cooling water flowing through the water pump or the neoprene water pump impeller will become damaged.

If you must run the engine with the boat out of the water, the best way to insure adequate water flow is to install a Correct Craft Fresh Water Flush. Be aware that some methods of providing water to the engine can allow water to be injected into the combustion chamber, possibly resulting in severe engine damage. Allow the engine to warm up to operating temperature by running it slowly at idle speed. When you run the boat in the water, run the engine at 1,000 to 1,500 RPM. Watch the water temperature gauge to prevent overheating.

Maintaining Transmission Fluid Level

- The boat must be sitting level.
- Open the engine box and pull the dipstick straight up and out of the transmission case.
- Wipe the fluid off of the dipstick with a clean cloth
- Close the engine box..
- Start the engine to fill all the cavities in the transmission and cooler. Make certain there is cooling water flowing to the water pump. Run the engine for thirty seconds.
- Shut the engine off, open the engine box and push the dipstick all the way down into the transmission case opening. This step should be performed as quickly as safety will permit.
- Remove dipstick and note level indicated. Add fluid to bring the level up to the top mark if necessary.
- If it was necessary to add oil, repeat the previous steps until the level is up to the top mark. Don't forget to replace the dipstick when you are done.

Add oil in small amounts to prevent over filling. If the transmission is over filled, the excess will have to be removed to prevent leakage or damage to the transmission.

Adjusting Water Pump Belt Tension (Ford Engines Only)

- Check the belt tension by pushing down on the upper strand of the belt at a point midway between the raw water and circulation pump pulleys.
- Belt should depress 1/4" (6.35mm). If it depresses more than 1/4", adjust the tension by loosening the water pump mounting bolts and pivoting pump to

obtain correct tension.

- After correct tension has been set, tighten mounting bolts.

Adjusting Alternator Drive Belt Tension

- Check belt tension by pushing down on the upper strand of the belt at a point midway between the alternator pulley and the circulating water pump pulley.
- Belt should depress 1/4" (6.35mm). If it depresses more than 1/4", adjust the tension by loosening alternator mounting bolts and pivoting the alternator to obtain correct tension.
- After correct tension has been set, tighten mounting bolts.

If at any time you are unsure of the proper checking or adjusting procedures consult your Correct Craft dealer for guidance.

Fuel Pumps

There are three different types of fuel pumps currently used on PCM engines. The three types are:

- 1) Mechanical
- 2) High Volume Low Pressure Electrical (Feed)
- 3) Low Volume High Pressure Electrical (Injection)

Mechanical and low pressure electrical pumps operate at 5 to 7 PSI, while high pressure pumps operate at 30 to 45 PSI, depending on the engine model.

Electrical Fuel Pump

The electric fuel feed pump used on all PCM engines is a high volume, low pressure, constant flow, rotary vane pump. It is a fully sealed marine approved fuel pump. The power source is 12 volt negative (-) ground and the pump operates at less than 5 amps.

When the ignition switch is turned on, the ECM closes the fuel pump relay causing the fuel pump to run.

If the ECM does not receive ignition reference pulses (engine cranking or running), it shuts "off" the fuel pump relay, causing the fuel pump to stop.

An inoperative fuel pump relay will result in an "Engine Cranks But Won't Run" condition.

PCM Fuel Control Cell

An inboard marine engine with electronic fuel injection can encounter several problems with fuel delivery which can cause poor performance or even result in an engine that will not run. A few of the problems which can occur due to an improperly designed fuel delivery system are:

- 1.) Vapor lock
- 2.) Debris in the Fuel

3.) Water Ingestion

4.) Air Ingestion

The FCC addresses these problems by eliminating vapor lock and air ingestion caused by fuel tank slosh and provides the necessary EFI filtration and water separation.

The PCM FCC is designed to properly deliver fuel to your electronically fuel injected (EFI) PCM marine engine under various operating conditions. The FCC is the first unit to combine a submersible high pressure electric fuel pump, fuel filter and water separator element in one unit. All fuel passes through the filter and water separator before being pumped to the fuel rail.

The system has been coupled with the proper sized feed pump to address the different problems encountered by a marine inboard electronically fuel injected engine. The FCC addresses and corrects all fuel delivery system problems we are currently aware of and does so with a minimum of electro-mechanical components.

To insure reliable maintenance-free operation, the FCC does not use floats, electric switches or other devices to regulate the fuel flow or level of the fuel. Moving components, electronic switches or contacts submerged in gasoline will eventually corrode, varnish or wear out and will require future maintenance. The design goal for the FCC was to provide maximum reliability while eliminating unnecessary components.

Principals of Operations

The FCC incorporates two fuel pumps to provide an uninterrupted flow of fuel to your PCM engine. Fuel is fed into the FCC by a low pressure, high volume electric fuel pump and also through the fuel pressure regulator that recirculates unused fuel from the fuel rail. This low pressure pump pushes fuel at a volume that is greater than the engine can use at maximum throttle. The high pressure pump inside the FCC bowl provides the necessary injector fuel pressure and volume to maintain proper engine performance and always has enough fuel to meet the maximum fuel requirements of the engine. The fuel pressure regulator on the engine controls fuel pressure and maintains a constant pressure across the fuel delivery system. Fuel not used by the engine is returned to the FCC canister. Fuel exits the FCC bowl at two points. The high pressure output pump sends fuel to the fuel injection system. All excess fuel in the FCC canister is routed back to the tank via the return line.

Battery

WARNING! Hydrogen and oxygen are produced during normal battery operation or charging. Sparks or flames near the vent openings can cause this mixture to ignite and explode. Sulfuric acid in the battery can cause serious burns if spilled on the skin or in the eyes. Proper eye protection and protective

clothing should be worn when performing battery maintenance. Flush away acid spills immediately with clear water. Contact a physician for medical treatment if acid comes in contact with your body.

A fully charged battery is your best insurance that your boat will start each time you want to go skiing. Batteries tend to discharge when not in use. The rate of discharge varies with the condition of the battery and/or the entire electrical system.

When checking the battery condition after a reasonable period of disuse, you may get a reading of 10 - 11 1/2 volts on a voltmeter. If the reading is 10 volts or below, the battery should be charged by either a charging device or by running the boat. If you start the boat, the voltage should immediately rise. Within one or two minutes the reading on the voltmeter should begin to level off at 13 - 14 volts. If the voltage does not rise or rises and stays above 15 volts, have the charging system checked out at your Correct Craft dealer.

S P E C I F I C A T I O N S

Battery:

Your battery should have 500 cold cranking amps @ zero degrees F (-18 c), 170 amps for a load test and 80 minutes of 25 amp rate reserve capacity. Do not reverse the battery cables on battery terminals. Do not spark battery cables against the terminals to check polarity. Damage to the charging system components may result if these precautions are not observed.

Important: The engine electrical system is negative ground. Failure to connect battery leads accordingly will damage the electrical system.

Fuel

Use any good grade of automotive regular or premium gasoline with a minimum average octane rating of 89. An 87 average octane gasoline may be used if 89 octane is not available.

New U.S. regulation requires posting average of research and engine octane: $(R+M)/2$.

Fuel will deteriorate during prolonged storage, causing damage to the fuel system gaskets, plastic parts and clogging the passages. Using a fuel stabilizer can help prevent this.

Do not use fuel that contains methanol alcohol or more than 10% ethanol alcohol. If pinging and/or other pre-ignition or detonation signs are present, a mechanical problem may exist which requires immediate attention by a qualified marine technician.

PCM reserves the right to refuse warranty on parts that are damaged from using an improper gasoline or engines improperly stored.

Engine Component Specifications

All these parts are marine approved and are required by law to insure the safety of the public. Repair or replacement in a manner inconsistent with its original configuration or replacement with a non-approved part is dangerous and could be a violation of the law.

CAUTION: Your Nautique comes equipped with a safety switch located next to the throttle that has a lanyard. This switch must be operational or the engine will not start or run.

WARNING! DO NOT bypass breakers or fuses under any circumstances short of an emergency. Severe damage to the electrical system and/or personal danger to the operator and other occupants of the boat could occur.

Engine Circuit Breakers on EFI Engines

The entire electrical system of the PCM GT40 engine is protected by a 60 amp circuit breaker. The ignition system is protected by its own 12 1/2 amp and the fuel pump circuit by its own 15 amp breaker. All protective devices are located on a panel at the rear of the engine.

PCM GM-based fuel injected engines have three fuses and a 60 AMP circuit breaker located at the rear of the engine behind the fuel injection ECM. The 60 AMP breaker protects the entire electrical system. The fuses protect the following EFI circuits.

- A. Fuel Pump Fuse - 15 amp
- B. Injector/ ECM Fuse - 10 amp
- C. ECM/ Battery Fuse - 15 amp

If the engine quits or will not start, turn off all accessories. If the battery has enough power to crank the engine using the starter, the breakers should be reset as follows: Push firmly on the red button of each breaker or replace any bad fuse. After the breaker is reset or the fuse is replaced, you should be able to start the engine.

If any breaker disconnects or fuse again blows or if resetting does not resolve the problem, bring your boat to your Correct Craft dealer to have a qualified marine mechanic inspect the engine to determine the cause of the problem.

Alternator is Rated for 50 Amps The regulator is integral solid state.

EFI Engines

Fuel injected engines are equipped with maintenance free distributors. No lubrication or maintenance is necessary for the life of your PCM engine.

Cooling System

The cooling system of each PCM engine incorporates a full circulation bypass system, permitting a full flow of water through the engine, even during

warmup. Two heavy-duty marine-type pumps are used to pump the water. A flexible impeller supply pump is used to keep the system full and to cool the exhaust system. A high volume circulation pump maintains full water circulation in the engine to prevent steam pockets and hot spots. This assures longer valve and piston ring life. A heavy-duty thermostat is used to control the amount of water which is discharged from the engine after the desired operating temperature is reached. The discharged water is automatically replaced by cool raw water from the supply side, maintaining a stable engine temperature through an exceptionally simple system. The hot water is discharged into the exhaust manifold water jackets.

If the engine begins to overheat, stop the boat immediately. Check the water intake on the bottom of the boat, water strainer, and the transmission oil cooler for obstructions. Check the water pump drive belts for proper tension and possible slippage. Look at the water lines for possible kinks.

WARNING: Removal of hoses from the engine while the boat is in the water may allow water to enter the bilge and could sink the boat. Remove hoses only if you have determined you can do so in complete safety.

On a Ford engine, a partial inspection of the flexible impeller of the supply pump can be made. Remove the top hose and drive belt from the supply pump and look into the pump chamber while slowly turning the pump pulley. A badly damaged impeller may be detected by doing this.

If a problem is found and corrected, do not attempt to restart the engine until it has cooled down to normal temperature. This is important to prevent engine damage due to thermal shock.

Fresh Water Cooling

Engines manufactured with an optional fresh water cooling system are identified with an “X” in the second position from the left in the model identifier on the engine identification tag.

The PCM freshwater cooling system consists of two (2) sections. The raw water section and the self contained fresh water section which is filled with a fifty-fifty mixture of anti-freeze and water.

The coolant in the freshwater section circulates through the engine block, heads and the intake manifold absorbing the heat created by the engine operation. When the engine is at operating temperature, the thermostat allows coolant to flow around the sides of the tubes in a heat exchanger where heat is transferred to the raw water flowing through the center of the heat exchanger tubes. The raw water is then directed into the manifolds and risers where it mixes with the exhaust.

If your engine begins to overheat, you should inspect this heat exchanger as

well as the previously mentioned areas.

Checking Coolant Level

WARNING: Reservoir is equipped with a 14 lb. (6.35kg) pressure cap. DO NOT remove the pressure cap when the engine is hot. This could cause personal injury. ALWAYS ALLOW THE ENGINE TO COOL OFF BEFORE ATTEMPTING TO REMOVE THE PRESSURE CAP. To remove the pressure cap, turn it a quarter of a turn to the left and allow pressure in the cooling system to escape. After the pressure is released, turn the cap all the way off.

The fresh water section of the heat exchanger should be checked each time you use the boat for proper coolant level. Coolant should be maintained at least one (1) inch (2.54cm) below the pressure cap seat in the expansion tank to allow room for coolant expansion.

If the coolant is escaping from the system, inspect the system components for leakage and correct as necessary. Pressure test the cap to insure proper operation. A defective cap may allow coolant to escape through the overflow during engine operation and be extremely difficult to detect. Contact your Correct Craft dealer at once if this problem can not be resolved by the above procedures.

Winterization Instructions

Long periods of storage can adversely affect the internal parts of the engine and fuel systems unless proper methods of preservation are used. Most Correct Craft dealers offer proper winterization services. If such service is not available or not utilized, the following procedures should be followed.

IMPORTANT: The following information is a guide to aid you in preparing your engine for prolonged storage. It is not intended to be an all inclusive instruction manual. After reading the guide completely, if you realize you do not have the proper tools or feel you do not understand any instructions, DO NOT attempt to begin this process. To proceed without a complete understanding of these instructions could result in severe engine damage. See your authorized PCM dealer. If you elect to proceed with the procedures outlined here, you agree to hold Correct Craft Inc. and PCM harmless should the engine be damaged or personal injury occur as a result of your actions.

WARNING: In order to prevent personal injury to you or others in the boat, whenever the engine is running, the engine box must be closed. Never operate the engine with the engine box open or while someone is in the proximity of the moving parts of the engine or transmission. Never open the engine box unless the engine is shut off and the engine's rotating parts are stationary and remain in a stationary position. Rotating machinery can cause injury and even death if an accident

should occur.

THE FOLLOWING INSTRUCTIONS SHOULD BE COMPLETED PRIOR TO REMOVING THE BOAT FROM THE WATER AND APPLY TO ALL PCM ENGINES.

Before storing, it is recommended that the fuel tank be filled to approximately 3/4's full. Calculate the necessary amount of fuel stabilizer such as Sta-bil and add the stabilizer to the fuel tank. Fill the tank to approximately 3/4's full and run the engine a sufficient length of time to ensure the fuel is properly distributed through the engine fuel system.

WARNING: Before starting your engine, always ventilate the engine compartment by running a properly operating bilge blower for at least four (4) minutes to remove any gas fumes from the engine compartment. It is important to check for fuel spillage or leaks after repairing or refueling.

Warm engine up to normal operating temperature. Turn engine off
Change crankcase oil and oil filter
Start engine and allow to idle for five (5) minutes. Turn engine off

CAUTION: Allow the engine to cool down to avoid burning yourself on hot engine parts before continuing with the following steps.

Remove all the spark plugs wires from the spark plugs, being very careful to mark each one. Remove all the spark plugs. Pour approximately 1 teaspoon of preservative oil into each spark plug hole. This oil will drain down into the cylinder. Turn the crankshaft several revolutions **by hand** to spread the oil evenly through the cylinders.

CAUTION: Do not use the starter to turn the engine over.

Install spark plugs and connect the proper spark plug wires. (When you recommission the boat, it will be necessary to remove spark plugs and spin engine to eliminate all possible oil prior to restarting.)

The following instructions should be done after the boat is removed from the water and apply to all PCM engines.

Remove, empty and clean the fuel filter shell. Reinstall with a new fuel filter and gasket.

NOTE: DO NOT re-use old fuel filter components; always replace with a new fuel filter and gasket.

Remove plug from the transmission oil cooler and the elbow between the thermostat housing and the circulating pump or remove hose from the water pump on engine block of engines without elbows.

Remove drain plugs and / or hoses from rear or lower end of both exhaust manifolds. Using a garden hose, flush both manifolds by removing the plugs at the front or the two hoses feeding water from the thermostat housing to the manifolds.

Disconnect the hose from the inlet fittings of the raw water supply pump and lower the end to drain any water that may be trapped.

Remove the raw water supply pump and remove the impeller. If inspection proves the impeller is in good condition, store it in an accessible spot for reinstallation at the end of the storage period. A damaged or badly worn impeller should be discarded and a new one installed at the end of the storage period. Removing the impeller during storage will prevent the impeller vanes from drying and taking a permanent "set."

Loosen water pump and alternator drive belts. Re-tighten to proper tension before starting engine.

Fresh Water Cooled Engines Only

On fresh water cooled engines with antifreeze in the cooling system, remove hoses from the rear of the manifolds for draining. Drain raw water from the heat exchanger and oil coolers by removing drain plugs and all raw water hoses (1" or 1 1/4" ID hoses only) by removing them from their fitting. Test the antifreeze solution to be sure it is strong enough to offer full protection against freezing. Antifreeze should be changed after winterization each year.

Raw Water Cooled Engines Only

Remove drain plugs on both sides of the engine block and engine oil cooler. Probe holes with a short piece of wire to make certain all the water has drained from the engine.

CAUTION! THE GM 5.7 KNOCK SENSOR IS LOCATED IN THE DRAIN HOLE FOR THE RIGHT SIDE OF THE ENGINE BLOCK. DO NOT DROP THE SENSOR OR IT MAY BE DAMAGED. WHEN REINSTALLING THE SENSOR, MAKE SURE THE THREADS ARE CLEAN AND TORQUE THE SENSOR 11 - 16 LB. FT.

When draining is completed, flush the block using a garden hose to flush salt

water or water with high silt content from the engine.

Allow to drain completely.

Install the block drain plugs and securely install the plug in the water pump elbow, **if equipped**, reinstall any hoses removed and reinstall manifold plugs.

Remove the block feed hose from the connection on the raw water supply pump. Elevate the end of the hose to a level higher than the top of the thermostat housing. Through the hose, fill the engine with a solution of 50% clean water and 50% permanent antifreeze such as Zerex or Prestone.

This helps prevent drying out the seals and gaskets, preventing the formation of hard dry scale in the water jackets and prevents freezing damage due to isolated pockets of trapped water that remains in the block.

When the system has been filled with the antifreeze mixture, reconnect and tighten the water hose to the water pump.

Exhaust pipes and engine air intakes should be closed off during prolonged storage periods to minimize condensation inside the engine.

Remove the battery and store in an area where above-freezing temperatures are maintained.

CAUTION: WHEN REINSTALLING THE BATTERY AFTER WINTERIZATION, BE SURE IT IS FULLY CHARGED. MAKE CERTAIN TO CONNECT THE POSITIVE CABLE TO THE POSITIVE BATTERY TERMINAL AND THE NEGATIVE CABLE TO THE NEGATIVE BATTERY TERMINAL. DO NOT REVERSE THE CONNECTIONS.

Winter Storage of Batteries

Battery companies are not responsible for battery damage either in winter storage or in dealer stock if the following instruction are not followed.

Remove battery from it's installation as soon as possible. Be sure vent caps are tight. Wash the battery with a diluted ammonia or soda solution to neutralize any acid present. Flush with clean water to remove grease, sulfate and dirt from the top surface. Wipe off all excess water with clean rags. Check water level, making sure that the battery plates are covered with water.

When adding distilled water to the battery, be extremely careful not to fill more than 3/16" (4.8mm) above the perforated baffles inside the battery. Battery solution or electrolyte expands from the heat caused by charging. If

the water level is more than the 3/16" (4.8mm), the electrolyte will overflow during charging.

Grease terminal posts well with cup grease or multipurpose lubricant and store the battery in a **cool, dry** place. Remove battery from storage every 30 - 45 days, check water level and put on charge for 5 - 6 hours at 6 amps. **DO NOT FAST CHARGE !**

RECOMMISSIONING

Assemble water pump and reinstall on engine.

Remove spark plugs and rotate engine by hand several times to remove oil from the cylinders. Do not use the starter to rotate the engine.

Install battery, making sure it is fully charged. Clean and lubricate terminals.

Check cooling system to be sure all hoses and the water pump are properly attached.

Re-adjust alternator drive belt and water pump drive belt tension.

Check engine alignment.

Check engine and transmission oil levels.

Check engine mount fasteners.

Before starting engine, refer to the instructions for starting in this manual.

Flushing Instruction

IMPORTANT: Drain the raw water section of the cooling system as part of the winterizing process for proper freeze protection. Failure to drain this water could damage the heat exchanger and possibly damage the engine during subsequent use.

When the boat is operated in salt water, flush the engine with fresh water periodically and before storage. If the engine is flushed while the boat is in the water, the water intake must have a sea cock installed between the water pickup and the water pump inlet.

CAUTION: Do not operate the engine without cooling water flowing through the water pump or the neoprene water pump impeller will become damaged.

If you must run the engine with the boat **out of the water**, attach a water hose to the pump inlet and run the engine slowly (650 - 700 RPM) in neutral to circulate the water. **DO NOT** increase engine speed above 1,000 RPM or water pump damage may occur. If running the engine with the boat **in the water**, run the engine at 1,000 to 1,500 RPM. Watch the water temperature gauge to prevent overheating.

WARNING: The maintenance instructions given in this manual are to be performed with extreme caution. Improper or careless actions on the part of the person performing maintenance on your boat or engine could result in severe personal injury, property damage and or death. Before performing any operating or maintenance procedure covered in this manual, be certain to read the entire manual in be certain you fully understand the procedure. Proceed only when you determine that you may do so in complete safety. Contact your Correct Craft/PCM dealer for any maintenance service which you are unable to perform in complete safety

PCM Python Engine Note: Caution: The PCM Python is a high-performance engine and may use more oil per engine hour of operation than other engines. Be sure to check the oil on a very regular basis, at least every two or three hours of operation. Failure to remedy an engine with insufficient oil could cause severe engine damage.

Cylinder Number Locations

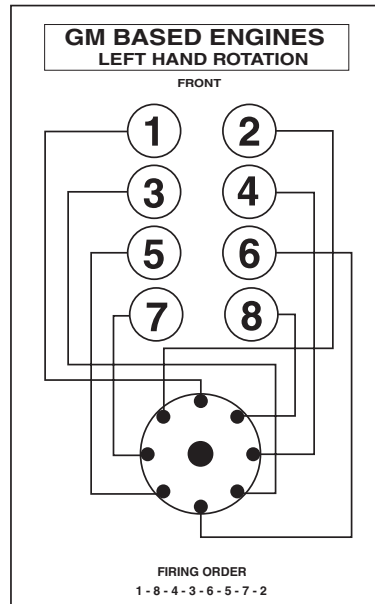
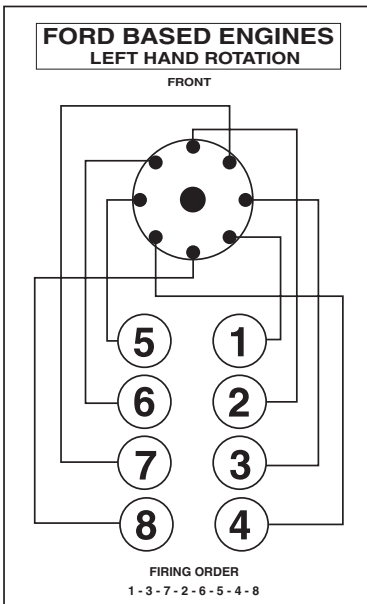

Maintenance Chart This chart indicates the intervals at which maintenance should be performed by a qualified person. Maintenance operations require caution to prevent personal injury and/or property damage. Proceed only after you have determined you may do so in complete safety or contact your Correct Craft dealer to perform this maintenance.

We recommend checking and servicing your boat at the most frequent interval listed below.

The inspection and maintenance schedule is based on average operating conditions and utility service. Under severe operation, the intervals should be shortened.

CAUTION: All engine waste fluids are considered to be hazardous wastes. Be certain these waste fluids are properly and legally disposed of in order to avoid polluting and or possible citation by authorities.

Service or check at the most frequent interval is recommended	Before each use	At the first 25 hours	Every 50 hours	Every 100 hours	Once each year
Engine oil level	x	x			
Change engine oil and filter		x	x	x	x
Transmission oil level	x				
Raw water strainer...sand or weeds	x	1	1	1	1
Water pump and alternator belt tension	x				
Fuel system hoses and connections for leaks	x	x	x	x	x
Cooling system hoses/connections for leaks	x				
Look for loose, damaged or missing parts	x				

The following should be done by a qualified technician

Propeller shaft alignment		x	x		x
Change transmission fluid				x	
Clean the flame arrestor			x		x
Clean crankcase ventilating system			x		x
Change fuel filter					x
Check the condition of spark plugs			x		x
Check battery electrolyte level			x	x	x
Check all electrical connections			x		x
Lubricate throttle and shift linkage pivot points			2		2

- 1) If the engine overheats, visually check the raw water strainer. If there are weeds, sand or debris, clean it out as described previously.
- 2) 30w engine oil.

Engine Troubleshooting

IMPORTANT: The following chart is a guide to aid you find and correct minor engine malfunctions. If the problem has not been corrected after following this guide, **NO NOT** attempt further repairs. See your Correct Craft dealer.

WARNING: Before attempting any checks or repairs, the battery cables MUST BE REMOVED from the battery to prevent possible personal injury and damage to equipment.

Trouble: Starter will not turn over.

Put control lever into the neutral position (straight up)

Clean and tighten the cables on the battery

Check electrolyte level in battery

Attach emergency cut-off lanyard to switch and yourself

Trouble: Engine will not start or is hard to start

Add fuel to the tank

Inspect fuel filter for a clog. Replace if necessary

Engine may be flooded. See flooded engine instructions in chpt 2

Inspect spark plugs: clean / gap or replace

Inspect distributor. Clean / replace

Check all electrical wires for wear or solid connection

Emergency cut-off switch not connected

Fuel tank vent clogged. Return the boat to dealer for service

Trouble: Poor engine idling or misses when idling

Check spark plug wires for corrosion

Inspect plugs: clean / gap or replace

Check electrolyte level in battery

Inspect distributor. Clean / replace

Fuel tank vent clogged. Return the boat to dealer for service

Inspect fuel filter for a clog. Replace if necessary

Trouble: Engine misses under acceleration or at high speed

Inspect distributor. Clean / replace

Inspect spark plugs: clean / gap or replace

Trouble: Oil pressure drops

Check oil level in the engine

Check oil filter for clog. Drain oil and replace filter

Trouble: Engine backfires

Make certain the spark plug wires are on the correct plugs

Trouble: Alternator will not charge the battery

Make certain the alternator belt is adequately tight

Check alternator wires for solid connections and wear

Tighten all loose bolts on the alternator

Check electrolyte level in battery

Trouble: Performance loss and poor acceleration

Inspect throttle cables to insure throttle is opening fully.

Inspect throttle cables for obstructions / binding conditions

Water in the bilge. Pump out the water

Boat may be overloaded. Reduce the load inside the boat

Inspect fuel filter for a clog. Replace if necessary

PCM Chevrolet APEX

Displacement CID / liter	350/5.7	
Bore (inches)	4.0"	
Stroke (inches)	3.480"	
Compression ratio	9.4 : 1	
Horsepower @ 5,000 RPM	320	
Battery recommended Min. CCA	500	note #4
Fuel injection (Multi Point)	8 (30#)	note #1
Spark plug number 14mm	MR43LTS (AC)	
MAX (Intermittent)RPM	5,000	note #9
Continuous cruise RPM's (max)	4,000	note #2
Idle speed (in forward gear)	650 - 700	ECM
Distributor (marine approved)	Delco Elec.	note #1
Ignition timing@1,000 rpm	10 BTDC	note #3 / 11
Spark plug gap	.045"	
Firing order	1-8-4-3-6-5-7-2	note #6
Fuel pump (low pressure feed)	5-6 psi	note #1
Fuel pump (high pressure injector)	40 - 45 psi	note #1 / 10
Oil pan capacity	6 qt. @ zero degree	#5 / 8
Oil filter	PH 30 (Fram)	note #12

PCM Ford GT-40

Displacement CID / liter	351/5.8	
Bore (inches)	4.0"	
Stroke (inches)	3.5"	
Compression ratio	8.3 : 1	
Horsepower @ 5,000 RPM	310	
Battery recommended Min. CCA	500	note #4
Fuel injection (Multi Point)	8 (24#)	
Spark plug number 14mm	AWSF22	note #7
MAX (Intermittent)RPM	4,800	note #9
Continuous cruise RPM's (max)	4,000 - 4,200	note #2
Idle speed (in forward gear)	650 - 700	ECM
Distributor (marine approved)	Motorcraft	note #1
Ignition timing@1,000 rpm	5 BTDC	note #3 A/B
Spark plug gap	.045"	
Firing order	1-3-7-2-6-5-4-8	note #6
Fuel pump (low pressure feed)	5-6 psi	note #1
Fuel pump (high pressure injector)	39 (+/- 3)psi	note #10
Oil pan capacity	4 qt.	note #5
Oil filter	PH 8A (Fram)	note #12

PCM Chevrolet Python

Displacement CID / liter	496 / 8.1	
Bore (inches)	4.25"	
Stroke (inches)	4.37"	
Compression ratio	9.1 : 1	
Horsepower @ 5,000 RPM	425	
Battery recommended Min. CCA	600	note #4
Fuel injection (Multi Point)	8	ECM
Spark plug number 14mm	Platinum TJ 14R-P15	
MAX (Intermittent)RPM	5,000	note #9
Continuous cruise RPM's (max)	3,800 - 4,000	note #2
Idle speed (in forward gear)	650	ECM
Distributor (marine approved)	None	ECM
Ignition timing@1,000 rpm	Preset	ECM
Spark plug gap	.060"	
Firing order	1-8-7-2-6-5-4-3	ECM
Fuel pump (low pressure feed)	5-6 psi	note #1
Fuel pump (high pressure injector)	43 (+/-2)psi	note #1
Oil pan capacity	8 qt.	note #5

PCM Chevrolet 305

Displacement CID / liter	305/5.0	
Bore (inches)	3.75"	
Stroke (inches)	3.48"	
Compression ratio	9.4 : 1	
Horsepower @ 5,000 rpm	275	
Battery recommended Min. CCA	500	note #4
Fuel injection (Multi Point)	TBI	note #1
Spark plug number 14mm	MR43LTS (AC)	
MAX (Intermittent)RPM	4,800	note #9
Continuous cruise RPM's (max)	4,000	note #2
Idle speed (in forward gear)	650 - 700	ECM
Distributor (marine approved)	Delco Elec.	note #1
Ignition timing@ 700	10 BTDC	note #3 / 11
Spark plug gap	.045"	
Firing order	1-8-4-3-6-5-7-2	note #6
Fuel pump (low pressure feed)	5-6 psi	note #1
Fuel pump (high pressure injector)	32 psi	note #1 / 10
Oil pan capacity	6 qt. @ zero degree	#5 / 8

Note #1 This part is a special " MARINE APPROVED" part and is required by law to insure the safety of the public. Repair or replacement in a manner inconsistent with its original configuration or replacement with a non-approved part is not only dangerous, but could be in violation of the law.

Note #2 Do not cruise at high limits of above range, unless propped to turn at or near maximum RPM's at full throttle

Note #3 A. Before setting ignition timing of EFI engines, the ECM on the GM TBI and MPI, must be set to the service mode and / or the SPOUT connector of the GT40, located near the engine oil fill tube, must be disconnected. Reconnect after setting timing.

B. Unleaded fuel of proper octane is recommended. Do not use fuels which contain methanol alcohol or more than 10% ethanol alcohol. If pinging and / or other pre-ignition or detonation signs are present, a mechanical problem may exist which requires immediate attention by a qualified marine technician.

Note #4 CCA Ratings are absolute minimums. Larger batteries are better suited for longer life and owner satisfaction WARNING: NO NOT reverse battery cables on battery terminals. DO NOT spark battery cables against terminals to check polarity. Damage to charging system components may result if these precautions are not observed.

Note #5 When changing the oil filter, run the engine and add only enough oil to bring the level back to the full mark on the dipstick to replenish the amount used by the filter.

Note #6 Spark plug wire routing diagrams are pictured on page 8.18

Note #7 Numbers listed are MOTORCRAFT numbers. AUTOLITE #303 or 3303 are equivalents to replace MOTORCRAFT # ASF32M AUTOLITE #763 in an equivalent to replace MOTORCRAFT # AWSF 22.

Note #8 6 quarts at 0 degree installed angle and 5 quarts at 15 degree installed angle. Dipstick calibrated full at 15 degrees and ¼ above full and low mark on HPO 454 (LN) When changing the oil filter, run the engine and add only enough oil to bring the level back to full mark on the dipstick to replenish the amount used by the filter.

Note #9 The PCM engine has electronic spark and RPM limiting control incorporated into the Electronic Control Module (ECM). Reduction in engine performance will be noted if excessive mechanical noise, detonation or spark knock is present.

Note #10 Fuel pressure reading listed for mulit point fuel injection is checked with the ignition on and the engine not running or with the engine running and the vacuum hose removed from the fuel pressure regulator. Fuel pressure on PCM engines equipped with a TBI may be checked either while the engine is running or not running. There is no vacuum hose on the fuel pressure regulator of a PCM engine equipped with TBI.

Note #11 GM based engines with Delco ignition systems and ECM controlled spark timing must be put into service mode before checking or setting the base timing. GM based engines with Delco ignition systems and distributor controlled timing require that AFTER THE ENGINE IS STARTED AND RUNNING an initial timing wire must be attached to the 12 volt B+ voltage source. Do not connect this wire to a 12 volt B+ voltage source until after the engine is running. If this wire is connected to a 12 volt B+ source while the engine is being started, the ignition control module (ICM) in the distributor may be damaged. If the engine shuts off and must be restarted while this wire is connected to a 12 volt B+ source, DETACH THIS WIRE BEFORE ATTEMPTING TO RESTART THE ENGINE.

Note #12 All engines equipped with remote oil filters use a Fram PH8A or equivalent filter.

Wire colors

Red	12 volt power
Black	12 volt ground
Pink	Fuel tank sender to gauge
Green	Bonding wire (grounds fuel fill and tank)
Purple	Ignition / Instruments / Emergency Shutoff Switch
Orange	Options
Dark Blue	Gauge lights
Yellow	Blower / clock / air/water temp
Light Blue	Oil pressure sending unit
Gray	Bow light / Stern light / Tach wire signal / Amp (hot)
Purple / red	Starter relay
Tan	Engine water temp sending unit
Light Green	Water temp warning light
Orange/Red	Hot to LCS pump
Orange / Green	Stbd ballast gauge
Orange/Black	Shower / Stern seat slide
Orange / Blue	Horn
Orange/Yellow	Hot to LCS pump
Yellow/Red	Ignition start
White / Black	Speakers
Green/Black	Speakers
Purple / Black	Speakers
Gray / Black	Speakers

9

Chapter 9

SERVICE RECORDS

IMPORTANT: Ownership Change Information

If you are the owner of a Pleasurecraft Marine engine which is out of warranty and would like to notify us of your ownership, please fill out this OWNERSHIP CHANGE FORM and return it to:

Pleasurecraft Marine Engine Company
P.O. Drawer 369
Little Mountain, SC 29075

Name _____

Address _____

City _____ State _____ Zip _____

I am the new owner of a Pleasurecraft Marine Engine with the following identification numbers: (for location of numbers see your Owner's Manual)

Engine model _____

Serial Number _____

Gear Model _____

Serial Number _____

Previous Owner:

Name _____

Address _____

City _____ State _____ Zip _____

Purchased From _____ Date _____

PROBLEM NOTIFICATION FORM

Important: All blanks must be completed to insure proper identification of your engine which is necessary to properly understand your request.

When completed mail this form to:

Pleasurecraft Marine
P.O. Drawer 369
Little Mountain, SC 29075

Engine Model _____

Serial Number _____

Owner Information

Name _____

Address _____

City _____ State _____ Zip _____

Phone Daytime _____ Evening _____

Selling Dealer _____

Dealer's Address _____

Date of Purchase _____ Boat Model _____

I would like to inform you of a problem I have experienced with the above engine.

My problem is:

My boat is located at:

Address _____

Telephone(____) _____

City _____ State _____ Zip _____

Requesters Signature _____ Date _____

Warranty Transfer

The PCM Limited warranty is transferable to a subsequent purchaser, but only for the remainder of the unused portion of the warranty term. This will not apply to products used in commercial applications.

DIRECT SALE BY OWNER

The second purchaser can be registered as the owner and retain the unused portion of the warranty term by sending in the original owner's plastic Warranty Registration Card, a copy of the bill of sale showing the date sold to the second owner, as well as a completed Warranty Transfer Application.

A new Warranty Registration Card will be issued to the second owner and the factory computer will reflect the change.

There is a transfer fee which must be submitted via certified check with the Transfer Application to PCM, P.O. Drawer 369, Little Mountain SC, 29075. The amount of the transfer fee (currently \$100.00) is the fee amount in effect at the time of actual transfer of the warranty. Contact your PCM dealer or PCM to determine that amount prior to submitting this application.

OUTSIDE THE UNITED STATES AND CANADA, PLEASE CONTACT YOUR LOCAL PCM DEALER OR THE PCM WARRANTY SERVICES AT (803) 345-1337 FOR INFORMATION ON HOW TO APPLY FOR THIS PROGRAM.

PCM WARRANTY TRANSFER APPLICATION

IMPORTANT! PURCHASER PLEASE NOTE: The checks listed below are designed to insure the safety and satisfaction of you, the owner. Therefore, we require that the following checks be performed at your expense by a qualified technician prior to delivery. By signing the check list, the technician certifies that he has checked the installation and operation of the engine and finds it to be performing properly. The owner or his agent should perform similar inspections periodically to identify any potential problems before they occur and to have any suspected defects checked and corrected immediately.

PRE DELIVERY CHECK LIST

Technician: Please check off all points and sign below.

Check engine oil	Check shaft alignment
Check timing	Check drive lube
Check control adjustments	Check exhaust hoses & clamps
Check battery charge	Check control travel
Check alternator for charge and level	Tighten all water lines
Tighten all drain plugs	Check all lube points
Check belts for tension	Set idle speed
Check for leaks, water, oil and exhaust	Check prop size and rotation

Engine Model: _____ Engine Serial: _____

Trans. Serial: _____ # of Engine Hours: _____

Date sold to 1st owner: _____

Date sold to 2nd owner: _____

I hereby certify that I have completed the pre-delivery checklist on engine

_____ and I have corrected any discrepancies or inconsistencies revealed by these checks. _____

Technician's signature _____ Date: _____

Company Name _____

Purchaser's signature _____ Date : _____

Supplemental Correct Craft/ PCM Customer Protection Addendum

In accordance with a special agreement between PCM and Correct Craft, Inc., all 2001 PCM Engines installed in 2001 Correct Craft Boats will be protected, subject to the terms of the PCM warranty, for a period of three (3) years. This addendum does not modify the PCM warranty as printed in the PCM operators manual, which states;

“No distributor, dealer, agent or employee of PCM is authorized to grant any other or further warranty or incur any additional warranty obligation on PCM’s behalf, in connection with the sale of its products.”

This agreement is for the 2001 model year only and affects PCM engines based on GM base engines only.

This addendum is a separate agreement for additional consideration received by PCM from Correct Craft for the 2001 model year.

This agreement is for the benefit of, and is notification to Correct Craft customers who purchase GM based PCM engines, that the PCM warranty department will honor claims for engine problems experienced by the owners of 2001 Correct Craft Boats for three (3) years as if those claims were made during the published term of the standard PCM warranty.

Claims outside warranty standard provisions will not be considered either during the normal warranty period or under this agreement.

This Addendum is to be inserted following the standard PCM warranty statement in the Operators manual and is to become a part of the PCM Operators manual supplied to Correct Craft and sent with each boat to the owner.

This Addendum contains the full agreement and no distributor, dealer, agent or employee of PCM is authorized to grant any other or further warranty or incur any additional warranty obligation on PCM’s behalf, in connection with the sale of its products.

NAUTIQUE FRIEND PROGRAM

It has been proven that experience and word-of-mouth are important promotional tools. Enthusiastic boat owners talk to their friends. Our statistics reveal that a high percentage of our Nautique owners learned about Correct Craft through a friend. We want to show our appreciation to these friends.

One year after the purchase date listed on an owner's warranty card, we send a "NEW OWNER SATISFACTION SURVEY". For the completion and return of this form, we offer a first anniversary gift of a Fashion Nautique T-shirt. It is our desire to keep in touch with our Correct Craft family of boat owners. We value our owners' comments and want to hear about the things we do right and/or the things we need to improve. One of the questions asked is, "How did you learn of Correct Craft?" This section adds a statement, "If a friend influenced you, please list his/her name and address." From this information, the President of Correct Craft sends that "Friend" a letter of thanks and a Fashion Nautique hat.

When a "Friend" appears on our list the second time, indicating success in encouraging another person to purchase a Nautique, this person receives a personal thank you letter from the President of Correct Craft with a certificate to return with the appropriate size indicated, and receive a Correct Craft T-shirt.

When a "Friend's" name is presented for the third time, this person will receive a personal letter from the President of Correct Craft with a certificate for a Correct Craft polo shirt.

For the fourth and succeeding times a "Friend" is listed, a personal letter will be mailed as well as a certificate for \$50 retail value of Fashion Nautique item(s).

Tell the story of your experiences with your boat, your dealer, and Correct Craft. When you are responsible for convincing a non-Correct Craft owner to buy a Nautique, encourage that new owner to give you credit for that introduction on his first anniversary survey form.

If you find that the information contained in this owners manual does not answer your specific question, then we invite you to contact your nearest dealer or your Correct Craft regional Warehouse for answers or necessary service. A list of the Correct Craft warehouses is given below, with the areas that they service.

CORRECT CRAFT LOCATIONS

MID-ATLANTIC CORRECT CRAFT

Route 30, Box 188
Speculator, NY 12164
518 - 548 - 9763
Maryland
New Jersey
New York
Pennsylvania (Eastern)
Virginia
Delaware
District of Columbia

MID-WEST CORRECT CRAFT

P.O. Box 216
Angola, IN 46703
219/833-2226
Illinois
Indiana
Iowa
Kansas
Kentucky
Michigan
Minnesota
Missouri
Nebraska
North Dakota
Ohio
Pennsylvania (Western)
South Dakota
West Virginia
Wisconsin

SOUTHWEST CORRECT CRAFT

22450 FM RD 1995
Lindale, TX 75771
903/882-8593
Arkansas
Louisiana
Oklahoma
Texas

NEW ENGLAND CORRECT CRAFT

142 Flagg Road
Rochester, NH 03839
603/332-7070
Connecticut

Maine
Massachusetts
New Hampshire
Rhode Island
Vermont

SOUTHEAST CORRECT CRAFT

7576 South Orange Ave.
Orlando, FL 32809
407/851-1965
Alabama
Florida
Georgia
Mississippi
North Carolina
South Carolina
Tennessee

WEST COAST CORRECT CRAFT

3 Auto Plaza Drive, Bldg. B
Folsom, CA 95630
916/985-4343
Alaska
Arizona
California
Colorado
Hawaii
Idaho
Montana
Nevada
New Mexico
Oregon
Utah
Washington
Wyoming

If, for any reason your nearest dealer or the warehouse servicing your territory cannot satisfactorily resolve your problem or answer your questions, then please feel free to contact our Customer Service Department at the main offices of Correct Craft, Inc., either by telephone or by mail.



Congratulations on your Correct Craft purchase!

Welcome to the Correct Craft Family. We hope you will have many years of boating enjoyment as a Nautique owner.

Join thousands of others in our association created exclusively for Correct Craft owners. You will find being a Nautique Owners Association (NOA) member can be rewarding. As a Gold member, you can enjoy great savings. Your Membership allows you to buy Fashion Nautique apparel & accessories at a 20% discount on current items. You may purchase admission to the Masters Waterski Tournament at Callaway Gardens, in Pine Mountain, Georgia at a special NOA discounted price over the published gate admission rates.

Gold Membership

Quest Hotel and Dining - Save 50% on Hotel accommodations at over 3,000 hotels around the world!

The Buying Network™ - Save up to 50% on over 300,00 brand name products

NOA Products & Select Discounts

Platinum Membership

Quest Traveller™ - Pay less for airline tickets, cruises, vacation packages & rental cars

SavRx Advantage - Save up 50% on most prescriptions at over 35,000 pharmacies

Coast to Coast Vision - Save up to 60% on eyewear, sunglasses, contact lenses, eye exams and surgical procedures (over 9,000 locations nationwide).

Quest Hotel and Dining, The Buying Network, NOA Products & Selected Discounts

Initial Membership includes:

T-shirt, Hat, Decals and Patches, Lapel Pin, Certificate and Membership Card, and subscription to our *Nautique News* and *NOA Newsletter*. Correct Craft's own magazine, the *Nautique News*, is a great source for latest news about the company, our products, activities, and current Fashion Nautique wear. The *NOA Newsletter*, the official publication of the Nautique Owners Association, features information about NOA benefits and services, events around world, member stories, inspirational articles, and updates on Correct Craft, Inc.

To show our appreciation to new Nautique owners, Correct Craft is

providing a complimentary, one-year, individual membership (valued at \$40). Registration is automatic upon Correct Craft's receipt of your warranty card. Your free Gold Individual Membership may be upgraded to a Gold Family Membership or to a Platinum membership at 50% off the standard rates. The Platinum Membership includes the Gold Membership with additional benefits Quest Traveller, The Buying Network and SavRX Advantage. Call the NOA Coordinator for additional membership information. Please include names and T-shirt sizes for yourself and up to four immediate family members, if you wish to upgrade to a Family membership.

Membership Application

(Owner)Name _____
 T-shirt ___ S ___ M ___ L ___ XL
 Address _____
 City _____ State _____ Zip _____
 Phone # (H) _____
 (W) _____
 Boat Model _____
 Hull Number _____
 Family Member 1: _____
 T-shirt ___ S ___ M ___ L ___ XL
 Family Member 2: _____
 T-shirt ___ S ___ M ___ L ___ XL
 Family Member 3: _____
 T-shirt ___ S ___ M ___ L ___ XL
 Family Member 4: _____
 T-shirt ___ S ___ M ___ L ___ XL

Please Upgrade my free **Gold Individual membership** to:

- ___ Gold Family, \$30 Fee
- ___ Platinum Individual, \$35 Fee;
- ___ Platinum Family, \$45 Fee

Individual Lifetime Membership:

- ___ Gold, 1-time \$200 Fee
- ___ Platinum, 1-time \$200 Fee PLUS \$60 annually

Individual Lifetime Platinum Members are automatic Lifetime Gold Members, to maintain Platinum status an annual \$60 fee is required for the additional benefits.

Method of Payment: Check _____
 Credit Card: Visa / Master Card _____
 Expire Date: _____

Return Completed application and fee to:
 N.O.A, 6100 S. Orange Ave., Orlando, FL 32809 / 1-888-628-8478

REQUEST FOR WARRANTY TRANSFER OF CORRECT CRAFT, INC. BOATS

**** A COPY OF THE PURCHASE RECEIPT MUST BE INCLUDED ****

Correct Craft's Lifetime Limited Warranty against structural defects in the hull, deck and stringer of model 2001 boats can be transferred, for a nominal fee, to the second purchaser within five (5) years from the date of sale to the first purchaser. The sale must be complete within the first five years. The limited warranty will be transferred upon the receipt and verification of: (1) this completed form, (2) a copy of the purchase receipt, (3) a payment of \$300.00 to "Correct Craft, Inc". This data **MUST BE RECEIVED WITHIN 15 DAYS OF THE SALE DATE**. The warranty will be transferred retroactive to the sale date. Review the warranty policy for details.

NOTE: THIS TRANSFER DOES NOT INCLUDE THE ENGINE.

Original owner _____

Boat model / type _____

Hull number CTC... _____

New owner information:

Name _____

Street / P.O. Box _____

City / State / ZIP Code _____

Date purchased _____ Phone # _____

The criteria listed above must be received within 15 days of the sale date. Submit it to Correct Craft Inc. 6100 South Orange Avenue, Orlando Fl 32809 Attention: Warranty department.

NOTE: Upon verification, the warranty will transfer retroactive to the sale date

Dash Plaque Order Form

Dash Plaques are available for a price of \$6.00 for 2000 and 2001 boat models and \$10.00 for 1987 - 1999 boats. Please check off the shape that matches your boat plaque and mail along with your payment to:

Correct Craft, Attn: Tracy Cumbus, 6100 S. Orange Ave., Orlando, FL 32809
Allow 4 to 6 weeks for the custom plaque order to be processed, made and shipped.

Desired Saying: *(Please Print)* _____

Hull Numbers: _____

\$6.00 Boats made in 2000 and 2001



\$10.00 Boats made in 1997 - 1999

Performance
engineered for:
YOUR FAMILY NAME

\$10.00 Boats made in 1990 - 1996

Performance
Engineered For:
The Smith Family

\$10.00 Boats made in 1987 - 1989

Performance
Engineered For:
Bob Smith

Plaque will be shipped to: *(Please Print)*

Name: _____

Address: _____

City: _____ State: _____ Zip: _____

Glossary

Aft Toward, at, or near the stern

Anode An electrode carrying a positive charge

Athwartship Across the boat, at right angles to the fore and aft centerline

Ballast Any solid or liquid weight placed in a boat to increase the draft, to change the trim.

Bilge The area under the floor between the stringers

Bitter end. The inboard end of a ship's anchoring cable which is secured to the boat.

Bow The forward end of the boat

Bulkhead A vertical partition or wall that divides one compartment from another

Camber The rise or crown of a deck

Cathode An electrode carrying a negative charge

Rub rail. The rubber extrusion that is fastened over the hull and deck joint

Cavitation A phenomenon in which low pressure within a liquid allows vapor bubbles to form

Centerline The middle line of a boat, extending from the stem to the stern

Chafing plate Bent plate for minimizing chafing of lines

Chine Abrupt change in transverse shape where a boat's side and bottom come together

Cleat A metal fitting that has two "horns" around which ropes may be fastened.

Davit A crane arm for hanging a boat above the water

Deadrise Transverse angle of the bottom of the hull

Deck The fiberglass portion of the boat above the hull

Draft The depth of the boat below the waterline measured vertically to the lowest part of the hull, propeller or rudder.

Fathom A measure of length equal to 6 linear feet, used for depths of water and lengths of anchor line.

Fender Devices built into or hung over the sides of a boat to prevent the boat from rubbing or chafing against other boats or piers

Fore and aft In line with the length of the boat's longitudinal

Freeboard The distance from the waterline to the upper surface of the side of the deck.

Heel The leaning of a boat to one side

Hull The structural body of a boat below the deck

Keel The principal fore and aft component of a boat's hull bottom, located along the centerline of the bottom; connecting the stem and the stern

Knot A unit of speed, equaling one nautical mile per hour; the international nautical mile is 1852 m (6076 ft)

Lee The side away from the wind

Limber hole A small hole or slot for the purpose of draining water

Line All rope in a boat or on the dock is referred to as “line”.

Load waterline The waterline on the boat’s hull where it is designed to float

Mid ship (amidship) In the vicinity of the mid-length of a boat, technically the exact half way between the bow and the stern

Port The left hand side of the boat when looking forward Opposite to starboard

Potable Fit for drinking (Rhymes with notable)

Propeller pitch Theoretical linear distance the propeller would move ahead during one complete revolution of it were turning with zero slippage.

Quay A masonry boat mooring structure usually built along the shore (Rhymes with see)

Rudder A vertical metal device used to steer the boat

Sacrificial anode Metal parts fitted to the hull of boat to provide a transfer of ions to the cathodic part of an electrolytic coupling and so protect other parts of the boat that would otherwise waste away through electrolysis

Shot A length of anchor chain equal to 15 fathoms or 90 feet

Slip The linear distance between the pitch (or advance) and the actual distance the propeller moves straight ahead through the water

Spring line A mooring rope oriented at a small angle to the boats centerline, usually attached to the boat mid ship

Square propeller A propeller that has pitch and diameter numbers that are equal (13 x 13)

Starboard The right hand side of the boat when looking forward Opposite to port.

Stem The hull side intersection with the keel at the bow

Stern The aft end of a boat

Stow To put away, To store cargo in a storage locker

Stringer Members under the floor that stiffen the hull bottom

Tiller An arm, attached to the rudder that turns the rudder

Transverse Pertaining to any member placed 90 degrees to centerline

Waterline The line of the water’s edge when the boat is afloat

Wetted surface The area of the immersed hull plus underwater gear

Revised 8/24/00